

To our customers,

Old Company Name in Catalogs and Other Documents

On April 1st, 2010, NEC Electronics Corporation merged with Renesas Technology Corporation, and Renesas Electronics Corporation took over all the business of both companies. Therefore, although the old company name remains in this document, it is a valid Renesas Electronics document. We appreciate your understanding.

Renesas Electronics website: <http://www.renesas.com>

April 1st, 2010
Renesas Electronics Corporation

Issued by: Renesas Electronics Corporation (<http://www.renesas.com>)

Send any inquiries to <http://www.renesas.com/inquiry>.

Notice

1. All information included in this document is current as of the date this document is issued. Such information, however, is subject to change without any prior notice. Before purchasing or using any Renesas Electronics products listed herein, please confirm the latest product information with a Renesas Electronics sales office. Also, please pay regular and careful attention to additional and different information to be disclosed by Renesas Electronics such as that disclosed through our website.
2. Renesas Electronics does not assume any liability for infringement of patents, copyrights, or other intellectual property rights of third parties by or arising from the use of Renesas Electronics products or technical information described in this document. No license, express, implied or otherwise, is granted hereby under any patents, copyrights or other intellectual property rights of Renesas Electronics or others.
3. You should not alter, modify, copy, or otherwise misappropriate any Renesas Electronics product, whether in whole or in part.
4. Descriptions of circuits, software and other related information in this document are provided only to illustrate the operation of semiconductor products and application examples. You are fully responsible for the incorporation of these circuits, software, and information in the design of your equipment. Renesas Electronics assumes no responsibility for any losses incurred by you or third parties arising from the use of these circuits, software, or information.
5. When exporting the products or technology described in this document, you should comply with the applicable export control laws and regulations and follow the procedures required by such laws and regulations. You should not use Renesas Electronics products or the technology described in this document for any purpose relating to military applications or use by the military, including but not limited to the development of weapons of mass destruction. Renesas Electronics products and technology may not be used for or incorporated into any products or systems whose manufacture, use, or sale is prohibited under any applicable domestic or foreign laws or regulations.
6. Renesas Electronics has used reasonable care in preparing the information included in this document, but Renesas Electronics does not warrant that such information is error free. Renesas Electronics assumes no liability whatsoever for any damages incurred by you resulting from errors in or omissions from the information included herein.
7. Renesas Electronics products are classified according to the following three quality grades: “Standard”, “High Quality”, and “Specific”. The recommended applications for each Renesas Electronics product depends on the product’s quality grade, as indicated below. You must check the quality grade of each Renesas Electronics product before using it in a particular application. You may not use any Renesas Electronics product for any application categorized as “Specific” without the prior written consent of Renesas Electronics. Further, you may not use any Renesas Electronics product for any application for which it is not intended without the prior written consent of Renesas Electronics. Renesas Electronics shall not be in any way liable for any damages or losses incurred by you or third parties arising from the use of any Renesas Electronics product for an application categorized as “Specific” or for which the product is not intended where you have failed to obtain the prior written consent of Renesas Electronics. The quality grade of each Renesas Electronics product is “Standard” unless otherwise expressly specified in a Renesas Electronics data sheets or data books, etc.
 - “Standard”: Computers; office equipment; communications equipment; test and measurement equipment; audio and visual equipment; home electronic appliances; machine tools; personal electronic equipment; and industrial robots.
 - “High Quality”: Transportation equipment (automobiles, trains, ships, etc.); traffic control systems; anti-disaster systems; anti-crime systems; safety equipment; and medical equipment not specifically designed for life support.
 - “Specific”: Aircraft; aerospace equipment; submersible repeaters; nuclear reactor control systems; medical equipment or systems for life support (e.g. artificial life support devices or systems), surgical implantations, or healthcare intervention (e.g. excision, etc.), and any other applications or purposes that pose a direct threat to human life.
8. You should use the Renesas Electronics products described in this document within the range specified by Renesas Electronics, especially with respect to the maximum rating, operating supply voltage range, movement power voltage range, heat radiation characteristics, installation and other product characteristics. Renesas Electronics shall have no liability for malfunctions or damages arising out of the use of Renesas Electronics products beyond such specified ranges.
9. Although Renesas Electronics endeavors to improve the quality and reliability of its products, semiconductor products have specific characteristics such as the occurrence of failure at a certain rate and malfunctions under certain use conditions. Further, Renesas Electronics products are not subject to radiation resistance design. Please be sure to implement safety measures to guard them against the possibility of physical injury, and injury or damage caused by fire in the event of the failure of a Renesas Electronics product, such as safety design for hardware and software including but not limited to redundancy, fire control and malfunction prevention, appropriate treatment for aging degradation or any other appropriate measures. Because the evaluation of microcomputer software alone is very difficult, please evaluate the safety of the final products or system manufactured by you.
10. Please contact a Renesas Electronics sales office for details as to environmental matters such as the environmental compatibility of each Renesas Electronics product. Please use Renesas Electronics products in compliance with all applicable laws and regulations that regulate the inclusion or use of controlled substances, including without limitation, the EU RoHS Directive. Renesas Electronics assumes no liability for damages or losses occurring as a result of your noncompliance with applicable laws and regulations.
11. This document may not be reproduced or duplicated, in any form, in whole or in part, without prior written consent of Renesas Electronics.
12. Please contact a Renesas Electronics sales office if you have any questions regarding the information contained in this document or Renesas Electronics products, or if you have any other inquiries.

(Note 1) “Renesas Electronics” as used in this document means Renesas Electronics Corporation and also includes its majority-owned subsidiaries.

(Note 2) “Renesas Electronics product(s)” means any product developed or manufactured by or for Renesas Electronics.

MOS INTEGRATED CIRCUIT
μPD7225

PROGRAMMABLE LCD CONTROLLER/DRIVER

The μPD7225 is a software-programmable LCD (Liquid Crystal Display) controller/driver. The μPD7225 can be serially interfaced with the CPU in a microcomputer and can directly drive 2, 3, or 4-time division LCD. The μPD7225 contains a segment decoder which can generate specific segment patterns. In addition, the μPD7225 can be used to control on/off (blinking) operation of a display.

FEATURES

- Can directly drive LCD
- Programmable time-division multiplexing
 - Static drive
 - Divide-by-2, 3, or -4 time division multiplexing
- Number of digits displayed
 - 7-segment
 - Divide-by-4 time division16 digits
 - Divide-by-3 time division10 2/3 digits
 - Divide-by-2 time division8 digits
 - Static4 digits
 - 14-segment
 - Divide-by-4 time division8 digits
- Bias method
 - Static, 1/2, 1/3
- Segment decoder output
 - 7-segment : Numeric characters 0 to 9, six symbols
 - 14-segment: 36 alphanumeric characters, 13 symbols
- Blinking operation
- Multi-chip configuration possible
- 8-bit serials interface
 - 75X series and 78K series compatible
- CMOS
- Single power supply

ORDERING INFORMATION

Part Number	Package
μPD7225G00	52-pin plastic QFP (14 × 14 mm)
μPD7225G01	52-pin plastic QFP (straight) (14 × 14 mm)
μPD7225GB-3B7	56-pin plastic QFP (10 × 10 mm)
★ μPD7225GC-AB6	52-pin plastic QFP (14 × 14 mm)

The information in this document is subject to change without notice. Before using this document, please confirm that this is the latest version.
 Not all devices/types available in every country. Please check with local NEC representative for availability and additional information.

PIN CONFIGURATION: (Top View)

- μPD7225G00 52-pin plastic QFP (14 × 14 mm)
- μPD7225G01 52-pin plastic QFP (straight) (14 × 14 mm)
- ★ μPD7225GC-AB6 52-pin plastic QFP (14 × 14 mm)

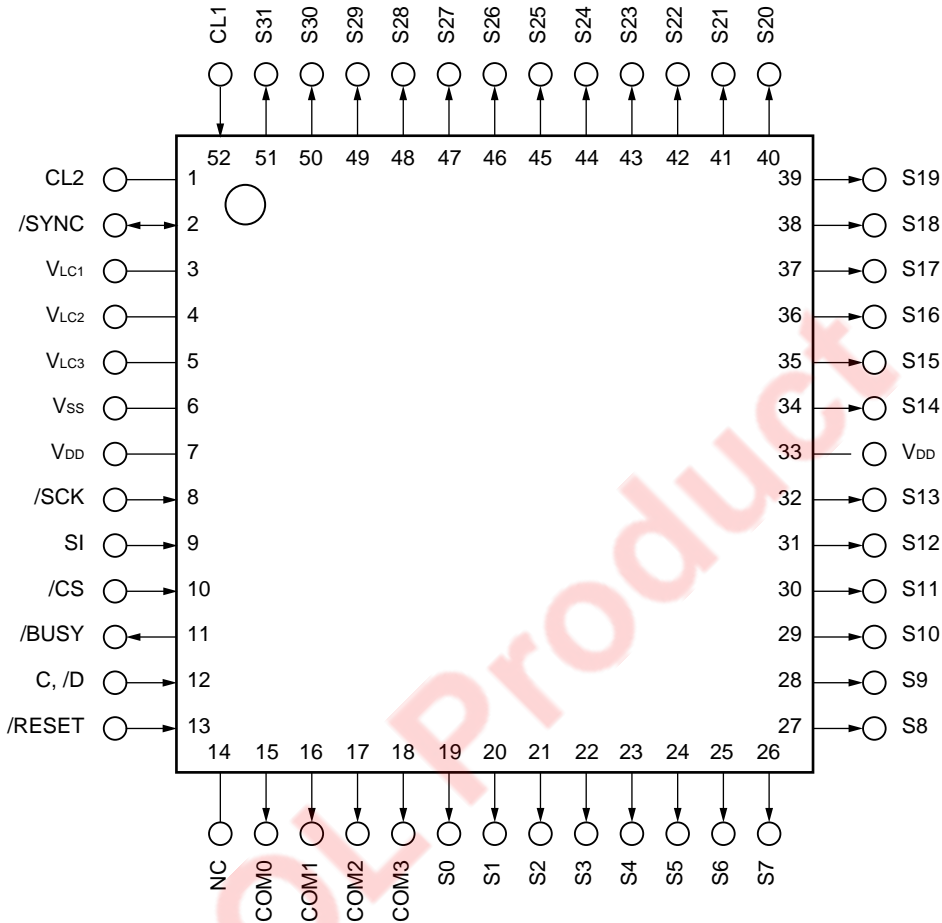

- | | | | |
|-----------|------------------|------------------------------------|--|
| SI | : Serial Input | CL1 | : External Resistor 1 (External Clock) |
| /SCK | : Serial Clock | CL2 | : External Resistor 2 |
| C, /D | : Command/Data | RESET | : Reset |
| /CS | : Chip Select | V _{LC1} -V _{LC3} | : Power Supply For LCD Drive |
| /BUSY | : Busy | V _{DD} | : Power Supply |
| SYNC | : Sync | V _{SS} | : Ground |
| S0-S31 | : Segment | IC | : Internally Connected |
| COM0-COM3 | : Common | | |
| NC | : Non-connection | | |

Remark /xxx indicates active low signal.

μPD7225GB-3B7 56-pin plastic QFP (10 × 10 mm)

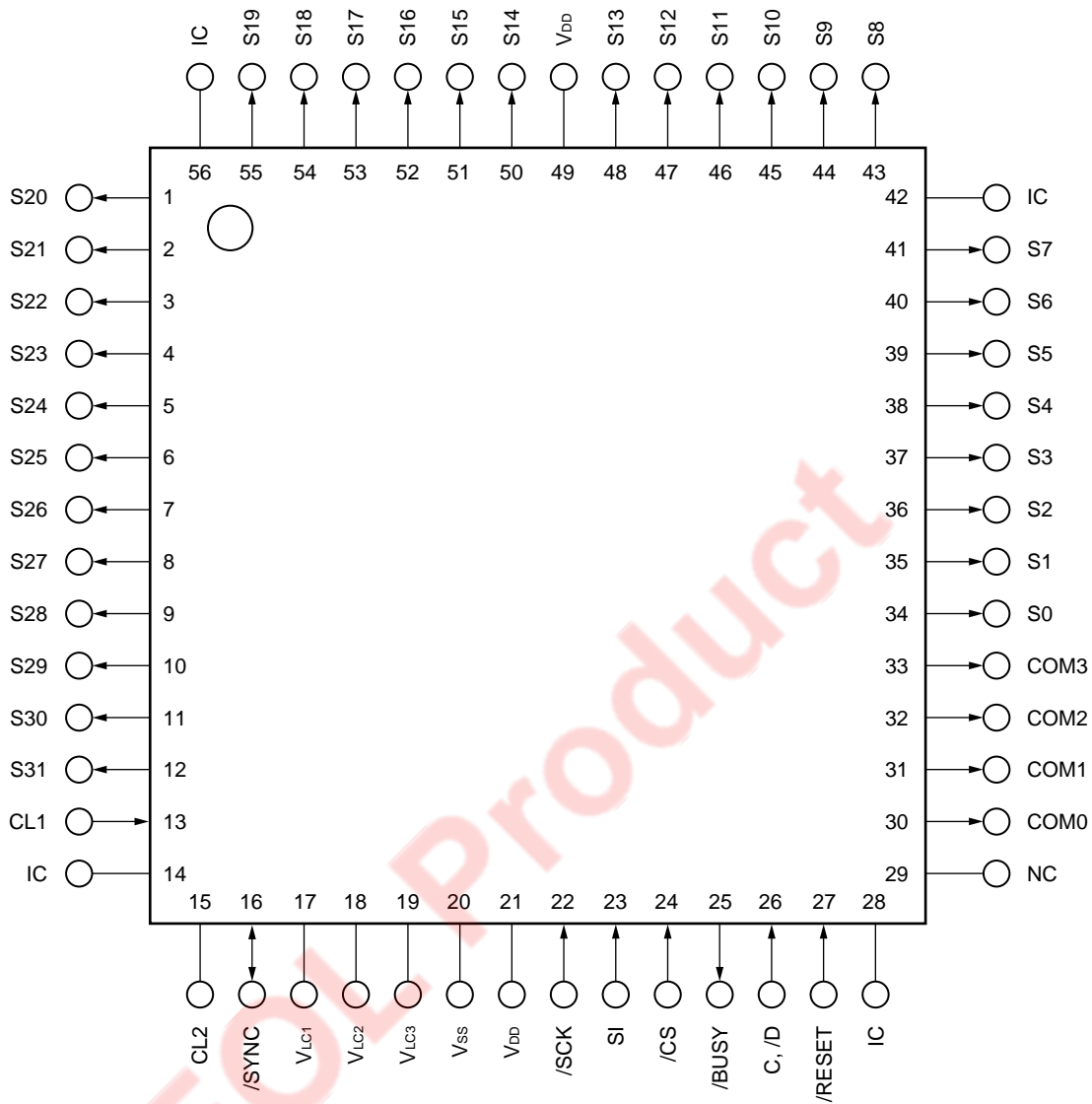

Note IC Pin must be connected to V_{DD} or left unconnected.

BLOCK DIAGRAM

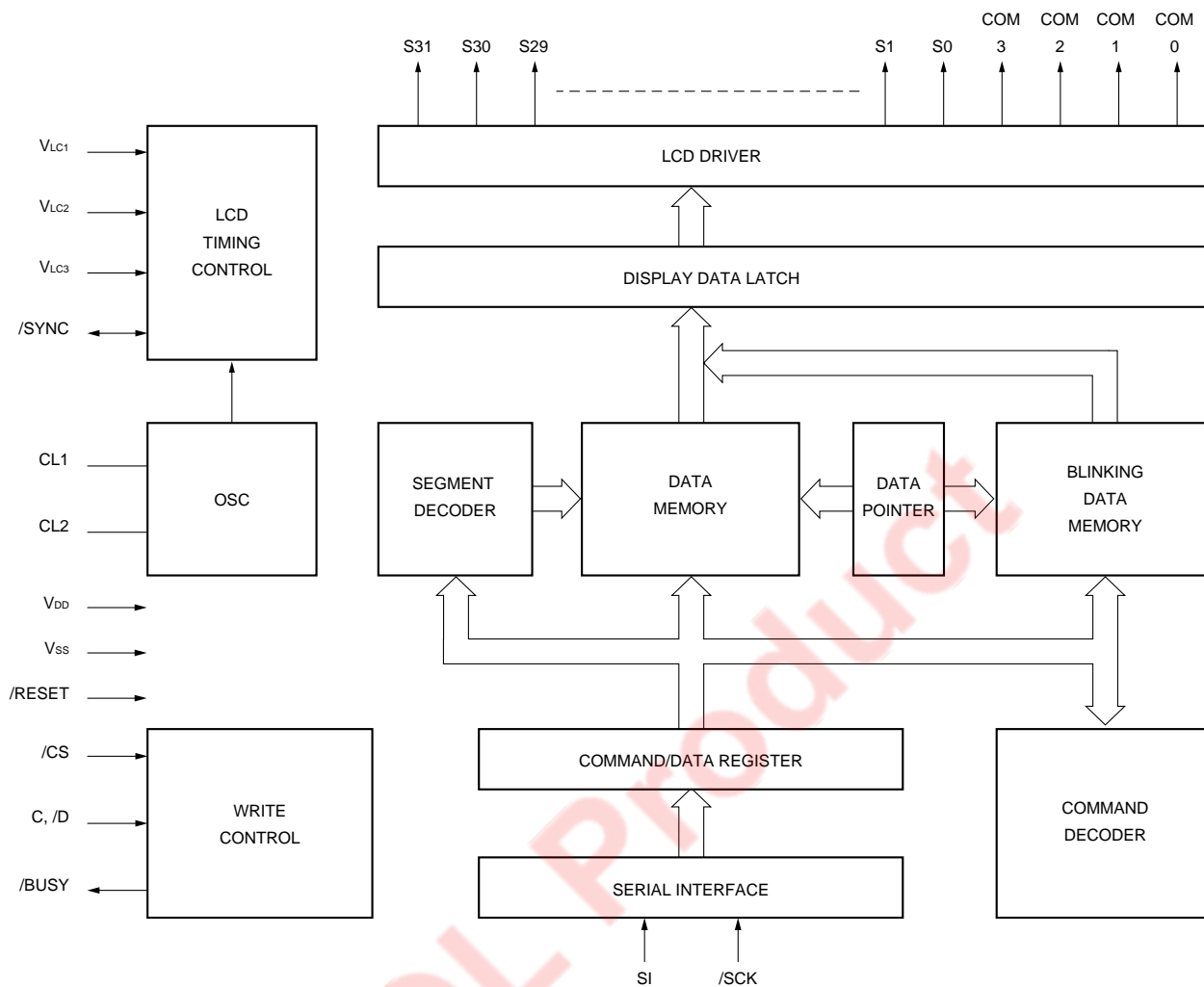

1. PIN FUNCTIONS

1.1 SI (Serial Input).....Input

This pin is used for inputting serial data (commands/data). Data to be displayed as well as 19 different commands for controlling the operation of the μPD7225 can be input to this pin.

1.2 /SCK (Serial Clock).....Input

This pin is used for inputting the shift clock for serial data (SI input). The content of the SI input is read into the serial register at the rising edge of this clock one bit at a time. /SCK input is effective when /CS = 0 and /BUSY = 1. If /BUSY = 0, this input is ignored. If /CS = 1, this signal is ignored regardless of the /BUSY status.

1.3 C, /D (Command/Data).....Input

This input indicates whether the signal input from the SI pin is a command or data. A low level indicates data; a high level indicates a command.

1.4 /BUSY.....Tri-state output

This is an active-low output pin that is used to control serial data input disable/enable. A low level disables serial data input; a high level enables serial data input. This pin becomes high impedance when /CS = 1.

1.5 /CS (Chip Select).....Input

When /CS is changed from high level to low level, the SCK counter in the μPD7225 is cleared and serial data input is enabled. At the same time, the data pointer is initialized to address 0. When /CS is set to high level after serial data is input, the contents of the data memory are transferred to the display latch and displayed on the LCD.

1.6 /SYNC (SYNChronous).....Input/Output

The /SYNC pin is used to make a wired-OR connection when the common pins are shared or when blinking operation is synchronized in a multi-chip configuration.

When the μPD7225 is reset (/RESET = 0), the /SYNC pin outputs the clock frequency (f_{CL}) divided by four (refer to **Figure 1-1**), and synchronizes the system clock ($f_{CL}/4$) of the μPD7225. When the reset is released (/RESET =1), the display timing of each μPD7225 is synchronized with the common drive signal timing shown in Figure 1-2.

Figure 1-1. /SYNC Pin Status During Reset (/RESET = 0)

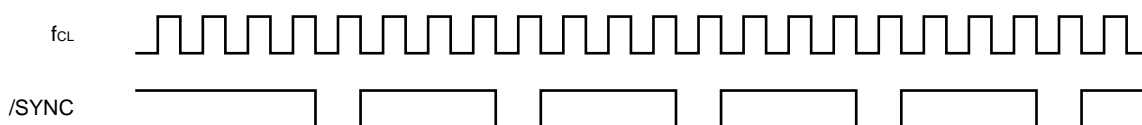
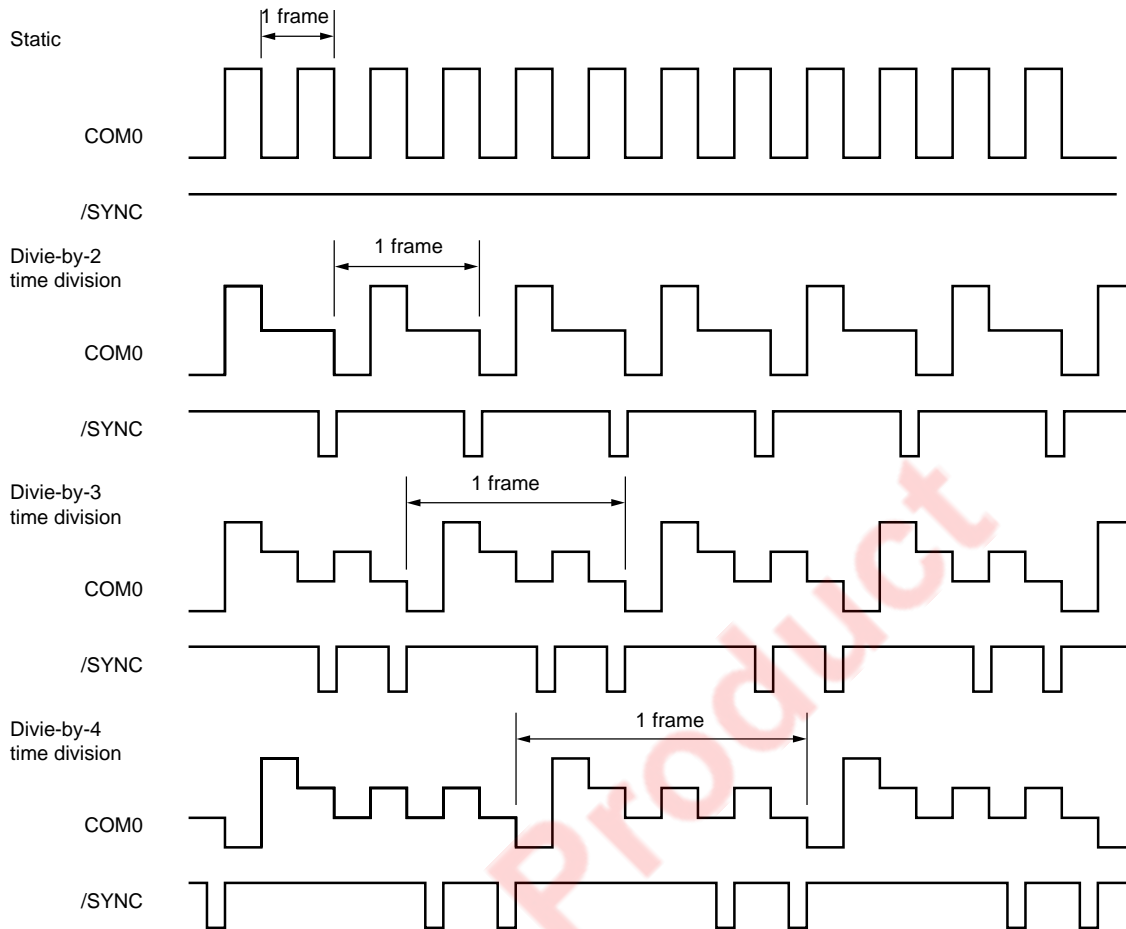

Figure 1-2. /SYNC Pin Status after Reset (/RESET = 1)



1.7 /RESET.....Input

This is an active low reset input pin.

1.8 S0-S31 (Segment).....Output

These pins output segment drive signals.

1.9 COM0-COM3 (COMmon).....Output

These pins output common drive signals.

1.10 CL1, CL2 (Clock)

A resistor is connected across these pins for internal clock generation. When inputting an external clock, use the CL1 pin for input.

1.11 VLc1, VLc2, VLc3

LCD driver power supply pin.

1.12 V_{DD}

Positive power supply pin. Either pin 7 or pin 33 can be used.

1.13 V_{SS}

GND pin.

EOL Product

2. INTERNAL SYSTEM CONFIGURATION

2.1 Serial Interface

The serial interface consists of an 8-bit serial register and a 3-bit SCK counter.

The serial register clocks in the serial data from the SI pin at the rising edge of /SCK. At the same time, the SCK counter increments (+1) the serial clock. As a result, if an overflow occurs (when eight pulses are counted), input from the SI pin is disabled (/BUSY = 0), and the contents of the serial register is output to the command/data register.

The /SCK should be set to high before serial data is input and after the data has been input (after eight clocks are input to /SCK).

Serial data must be input to the SI pin beginning with MSB first.

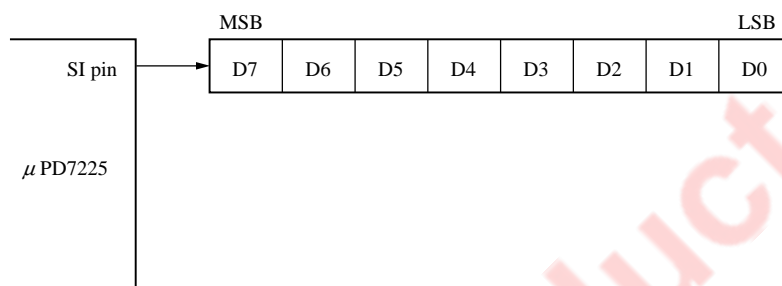

2.2 Command/Data Register

The command/data register latches the contents of the serial register in order to process the serial data clocked into the serial register. After the serial data is latched, if the clocked in data is specified as command, the command/data register transfers its contents to the command decoder. If specified as data the command/data register transfers its contents to data memory or the segment decoder.

2.3 Command Decoder

When the contents of the command/data register are specified as a command (C, /D was high when data was input), the command decoder, clocks in the contents of the command/data register and controls the μPD7225.

2.4 Segment Decoders

The μPD7225 has a 7-segment decoder for use with divide-by-3 and divide-by-4 time division, and a 14-segment decoder for use divide-by-4 time division.

The 7-segment decoder can generate signals for numeric characters 0 to 9 and six different symbols. The 14-segment decoder can generate signals for 36 alphanumeric characters and 13 different symbols. When the WITH SEGMENT DECODER command is executed, if the contents of the command/data register are specified as data, the contents will be input to the segment decoder, and converted to display codes, and then automatically written to the data memory. Whether to select the 7-segment decoder or 14-segment decoder is determined by the most significant bit (bit 7) of the data input to the segment decoder. If the most significant bit is 0, the 7-segment decoder will be selected. If it is 1, the 14-segment decoder will be selected. If the 7-segment decoder is selected (however, divide-by-3 and divide-by-4 time division), the lower 4 bits (bit 3 to bit 0) of the input data (C, /D = 0) will be decoded and written to the data memory.

If the 14-segment decoder is selected (however, divide-by-4 time division), the lower 7 bits of the input data (C, /D = 0) will be decoded and written to the data memory.

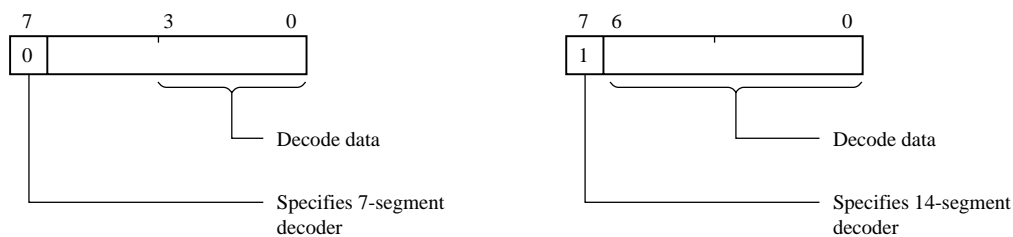

When displaying the output of the segment decoder (display data) on the LCD, use an LCD configured as shown in Figure 2-1 or Figure 2-2.

If another type of LCD is used, the displayed pattern will be different.

Figure 2-1. 7-Segment Type LCD

When configuring the LCD for divide-by-3 time division mode, connect as follows:

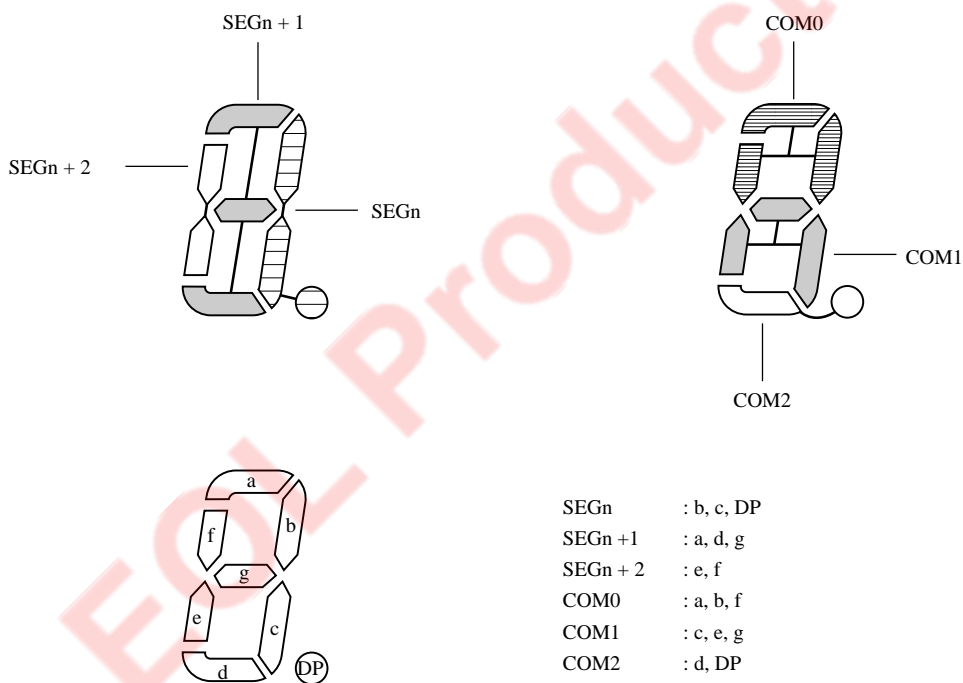

When configuring the LCD for divide-by-4 time division mode, connect as follows:

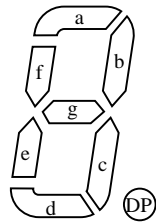
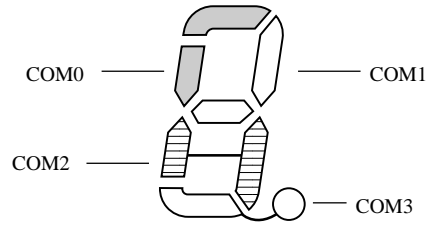
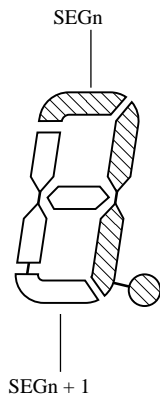

- SEGn : a, b, c, DP
- SEGn + 1 : d, e, f, g
- COM0 : a, f
- COM1 : b, g
- COM2 : c, e
- COM3 : d, DP

EOL Product

Figure 2-2. 14-Segment LCD

The 14-segment type LCD can be used only in the divide-by-4 time division mode. For the 14-segment LCD type, connect segments and commons as follows:

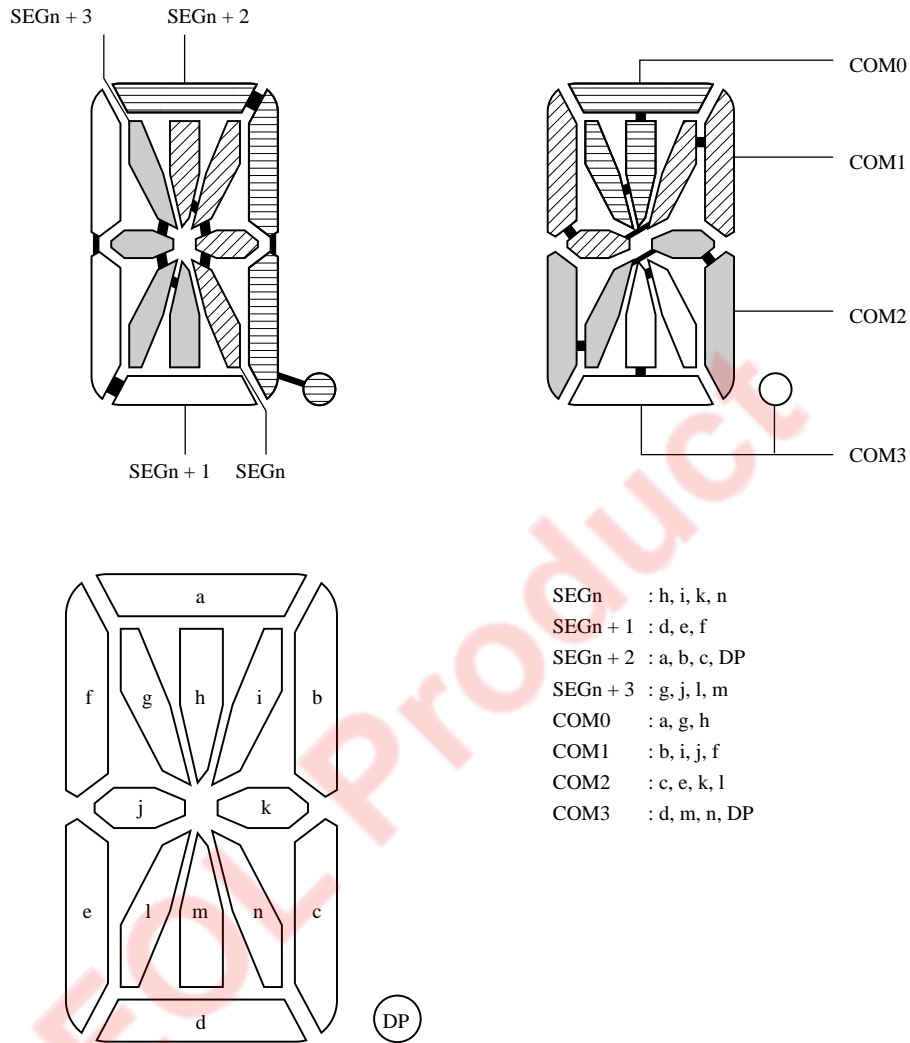

The following shows the input data and display pattern, and the configuration of the display data which is automatically written into the data memory. For the 7-segment type, the lower 4 bits (D3 to D0) are decoded. For the 14-segment type, the input data and display pattern correspond to 8-bit ASCII code. The first address to which the display data is written is indicated as address N.

Figure 2-3. 7-Segment LCD

Data (HEX)	Display pattern	Data memory					
		Divide-by-3 time division			Divide-by-4 time division		
		N+2	N+1	N	N+1	N	
00		3	5	3	D	7	
01		0	0	3	0	6	
02		2	7	1	E	3	
03		0	7	3	A	7	
04		1	2	3	3	6	
05		1	7	2	B	5	
06		3	7	2	F	5	
07		0	1	3	0	7	
08		3	7	3	F	7	
09		1	7	3	B	7	
0A		0	2	0	2	0	
0B		3	7	0	F	1	
0C		3	5	0	D	1	
0D		0	6	0	A	0	
0E		2	6	2	E	4	
0F		0	0	0	0	0	

Figure 2-4. 14-Segment LCD

		Upper bit																					
		A				B				C				D									
Data (HEX)	Display pattern	Data memory				Display pattern	Data memory				Display pattern	Data memory				Display pattern	Data memory						
		N+3	N+2	N+1	N		N+3	N+2	N+1	N		N+3	N+2	N+1	N		N+3	N+2	N+1	N			
0		0	0	0	0		4	7	E	2		A	7	C	0		2	3	6	4			
1		/					0	6	0	0		2	7	6	4		0	7	E	8			
2							2	3	C	4		8	7	8	5		2	3	6	C			
3							2	7	8	4		0	1	E	0		1	5	8	4			
4							2	6	2	4		8	7	8	1		8	1	0	1			
5							2	5	A	4		2	1	E	4		0	6	E	0			
6							2	5	E	4		2	1	6	4		4	0	6	2			
7		0	0	0	2		0	7	0	0		0	5	E	4		4	6	6	8			
8		0	0	0	A		2	7	E	4		2	6	6	4		5	0	0	A			
9		5	0	0	0		2	7	A	4		8	1	8	1		9	0	0	2			
A		F	0	0	F	/					0	6	C	0		4	1	8	2				
B		A	0	0	5						2	0	6	A	/								
C		/					4	0	8	2		0	0	E					0		1	0	0
D						2	0	0	4		2	0	8	4		1	6	6	2	/			
E						/					1	0	8	8		1	6	6	8				
F										4	0	0	2		0	7	E	0	/				

Lower bits

2.5 Data Memory/Data Pointer

The data memory is a memory which stores display data (32 × 4 bits). Data input by serial transfer, command immediate data, etc., is written to the data memory.

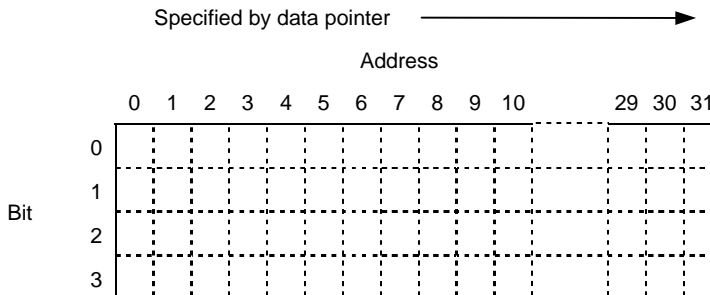

In the data memory, either data from the serial register (when the segment decoder is not used) or data from the segment decoder (when the segment decoder is used) is written as display data.

When the segment decoder is not used, all bits or the lower 4 bits of the serial data (C, /D = 0) input to the serial register are assigned and written to the specific bits in location 2 to location 4 in the data memory according to the specified time division. When the segment decoder is used, the contents of the serial register (C, /D = 0) are decoded by the segment decoder, and the corresponding display data are allocated to the location specified in data memory by the time division specification (divide-by-3, -4 time division) and the MSB (Most Significant Bit) of the serial data. (1) to (4) below describe these operations.

The contents of the data memory can be modified in 4-bit units or in bit units using a command.

(1) Static

The lower 4 bits of the contents of the serial register are written to bit 0 in each address (the upper 4 bits are ignored).

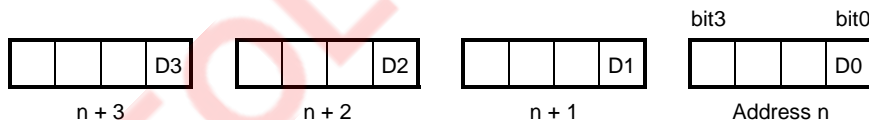

Only the content of bit 0 in each address are effective as display data.
After the data is written, the data pointer points to address n + 4.

(2) Divide-by-2 time division

The contents of the 4 even bits of the serial register are written to bit 0 in the four addresses, and the contents of 4 odd bits of the serial register are written to bit 1.

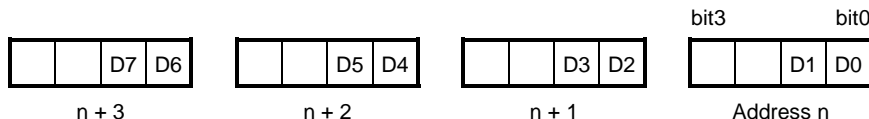

The contents of bits 0 and 1 of each address are effective as display data.
After the data is written, the data pointer points to address n + 4.

(3) Divide-by-3 time division

The contents of the 8 bits of the serial register of the segment decoder output (8 bits) are written to bits 0, 1, and 2 of each address. In this case, 0 will be automatically written to bit 2 of address $n + 2$. For segment decoder output, 0 will also be automatically written to bit 2 (D2) of address n .

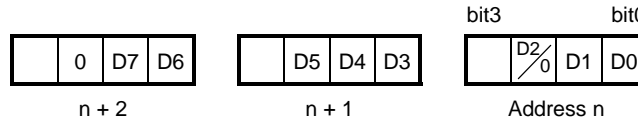

The contents of bits 0, 1, and 2 of each address are effective as display data.

After the data is written, the data pointer points to address $n + 3$.

The segment decoder output written to the data memory corresponds to segments (a to g, DP) shown in Figure 2-1 as follows:

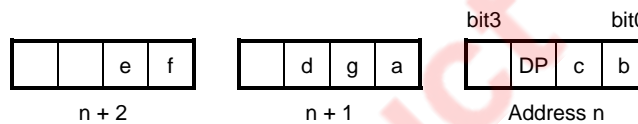

(4) Divide-by-4 time division

The contents of the 8 bits of the serial register or the segment decoder output (8 bits) are written to bits 0, 1, 2, and 3 of each address. For segment decoder output, 0 is automatically written to bit 3 (D3) of address n .

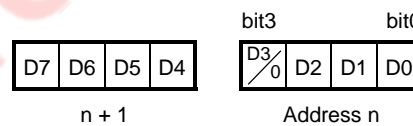

The contents of all bits of each address are effective as display data.

After the data is written, the data pointer points to address $n + 2$.

When 7 segments are used, the segment decoder output written to the data memory corresponds to segments (a to g, DP) shown in Figure 2-1 as follows:

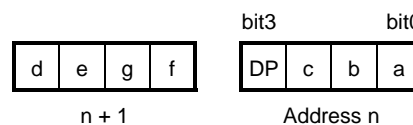

When 14 segments are used, the segment decoder output is written to bits 0, 1, 2, and 3 of each address. In this case, 0s are automatically written to bit 3 of address $n + 2$, and bit 0 of address $n + 1$.

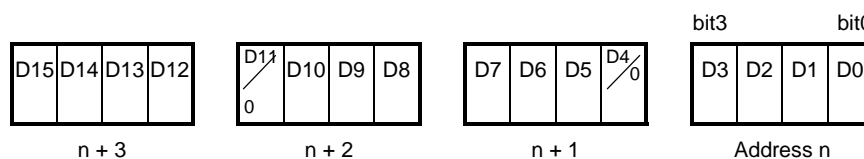

All bits of each address are effective. After the data is written, the data pointer points to address $n + 4$. The segment decoder output written to the data memory corresponds to segments (a to n, DP) shown in Figure 2-2 as follows:

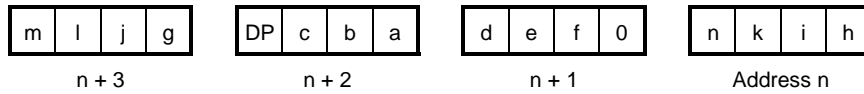

All contents of the 32×4 -bit data memory are transferred to the 32×4 -bit display data latch when the /CS is set to high. In this case, if the DISPLAY ON command has been set, the contents of the display data latch are converted to the segment drive signal in 32-bit units in synchronization with COM0-COM3 signals, and output from the segment pins.

The figure below shows the relationship of the data memory, segment pins, and common signal selection timing.

Figure 2-5. Data Memory, Segment Pins, and Common Signal Selection Timing

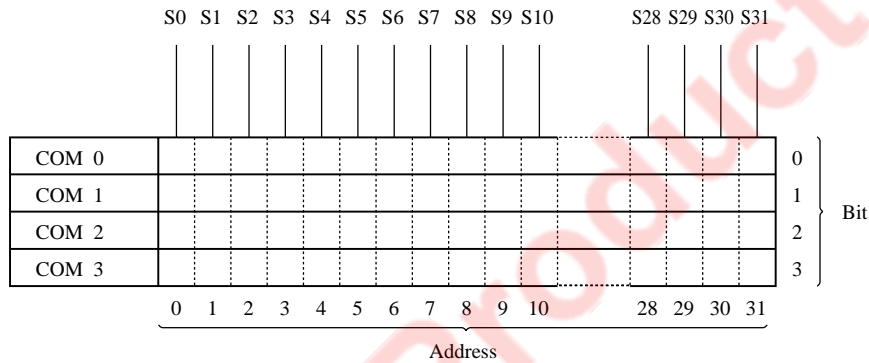

The data pointer (5 bits) specifies the address (0-31) of the data memory to which the display data will be written (at the same time, the data pointer specifies the blinking data memory address (0-31)). The LOAD DATA POINTER command is used to set the address to the data pointer (the data pointer can be initialized by setting the /CS to low). When the data pointer is counted up to 31, it then becomes 0 at the next count, and thus it repeats the operation shown below.

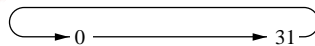

It should be noted that, if display data is written sequentially from address 0 in the divide-by-3 time division mode, addresses 30 and 31 will not be written. However, if the data is written in the divide-by-3 time division mode again, data will be written from addresses 30, 31, followed by 0 so that the display data previously written to address 0 will be modified.

2.6 Blinking Data Memory

The blinking data memory stores blinking data used to control display on/off operation (blinking). Blinking operation can be performed in segment units. Each bit in blinking data memory corresponds to a bit in the data memory; if a bit in the blinking data memory is set to 1, the corresponding segment will blink.

The blinking data memory is addressed by the data pointer at the same time the data memory is addressed. Data is written by using the WRITE BLINKING DATA MEMORY command, and bit manipulation can be performed by using the AND BLINKING DATA MEMORY, or OR BLINKING DATA MEMORY command. The BLINKING ON command is used to initiate blinking operation or select the blinking interval (refer to **3.2 Blinking Frequency Setting**)

2.7 Display Data Latch

The display data latch stores the data of the 32×4 -bit segment driver. Each bit of the display data latch corresponds to a bit in the data memory. All contents of the data memory are transferred to the display data latch at the rising edge of /CS, and the contents displayed on the LCD are modified. If blinking is set, the contents of data memory are modified by the contents of blinking data memory and the resulting values are transferred to the display data latch.

The display data written to the display data latch is successively selected by the control function performed by the LCD timing control, and converted to segment drive signal before output.

2.8 LCD Driver

The LCD driver consists of the segment driver and the common driver, and generates the segment drive signal and common drive signal.

The segment driver outputs a segment signal so that the relationship with the common drive signal is select level if the drive data stored in the display data latch is 1. If the drive data stored in the display data latch is 0, the output of the segment driver will be non-select level.

The common drive signal sequentially drives the LCD common poles according to the time division specification.

2.9 LCD Timing Control

The LCD timing control generates the LCD drive timing according to the number of time divisions, the frequency division ratio, and bias method, and supplies it to the LCD driver. In addition, the LCD timing control outputs a /SYNC signal from the /SYNC pin in order to synchronize the display timing of each μ PD7225 when configured in a multi-chip configuration.

In a multi-chip configuration, the common signal can be used in common or blinking operation can be synchronized by making a wired-OR connection with the /SYNC pin of each μ PD7225.

3. FRAME FREQUENCY AND BLINKING FREQUENCY SETTING

3.1 Frame Frequency Setting

The frame frequency is set according to M1, M0 (number of time-divisions setting), and F1, F0 (frequency division ratio) as indicated in the figure below.

Figure 3-1. Frame Frequency Setting

F1,F0 \ M1, M0		Static		Divide- by-2 time division		Divide- by-3 time division		Divide- by-4 time division	
		0	1	1	1	1	0	0	0
0	0	$\frac{f_{CL}}{2^7}$		$\frac{f_{CL}}{2^7 \times 2}$		$\frac{f_{CL}}{2^7 \times 3}$		$\frac{f_{CL}}{2^7 \times 4}$	
0	1	$\frac{f_{CL}}{2^8}$		$\frac{f_{CL}}{2^8 \times 2}$		$\frac{f_{CL}}{2^8 \times 3}$		$\frac{f_{CL}}{2^8 \times 4}$	
1	0	$\frac{f_{CL}}{2^9}$		$\frac{f_{CL}}{2^9 \times 2}$		$\frac{f_{CL}}{2^9 \times 3}$		$\frac{f_{CL}}{2^9 \times 4}$	
1	1	$\frac{f_{CL}}{2^{11}}$		$\frac{f_{CL}}{2^{11} \times 2}$		$\frac{f_{CL}}{2^{11} \times 3}$		$\frac{f_{CL}}{2^{11} \times 4}$	

Remark f_{CL} = Clock oscillation frequency

3.2 Blinking Frequency Setting

The blinking frequency can be set in two settings by K0 in the BLINKING ON command.

Figure 3-2. Blinking Frequency Setting

K0	Blinking frequency
0	$\frac{f_{CL}}{2^{17}}$
1	$\frac{f_{CL}}{2^{16}}$

Remark f_{CL} = Clock oscillation frequency

4. LCD DRIVE POWER SUPPLY PIN VOLTAGE SETTING

The bias method for setting the LCD drive power supply pin allows a different voltage to be supplied to each pin.

Figure 4-1. Voltage Setting

	V _{LC1}	V _{LC2}	V _{LC3}
Static	V _{DD}	V _{DD} - V _{LCD}	V _{DD} - V _{LCD}
1/2 bias	V _{DD} - $\frac{1}{2}$ V _{LCD}	V _{DD} - $\frac{1}{2}$ V _{LCD}	V _{DD} - V _{LCD}
1/3 bias	V _{DD} - $\frac{1}{3}$ V _{LCD}	V _{DD} - $\frac{1}{3}$ V _{LCD}	V _{DD} - V _{LCD}

Remark V_{LCD} : LCD voltage

The following shows a circuit example which supplies voltages between V_{DD} and V_{SS} as the LCD drive reference voltage.

(1) Static

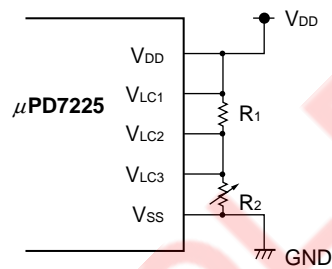

$$R_1 = \frac{V_{LCD}}{V_{DD} - V_{LCD}} \times R_2$$

- V_{LCD}: LCD drive voltage
- R₂ is used for contrast adjustment.

(2) Divide-by-2, -3 time division (1/2 bias)

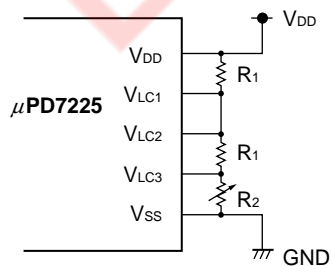

$$R_1 = \frac{V_{LCD}}{2(V_{DD} - V_{LCD})} \times R_2$$

(3) Divide-by-3, -4 time division (1/3 bias)

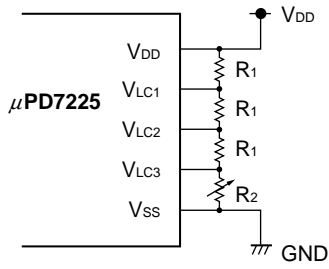

$$R_1 = \frac{V_{LCD}}{3(V_{DD} - V_{LCD})} \times R_2$$

EOL Product

5. CLOCK CIRCUIT

The clock oscillator can be configured by connecting a resistor (R) across the CL1 and CL2 clock pins. When using the external clock, CL1 can be used to input the external clock (CL2: Open).

Figure 5-1. External Circuit for Clock Oscillation Pins

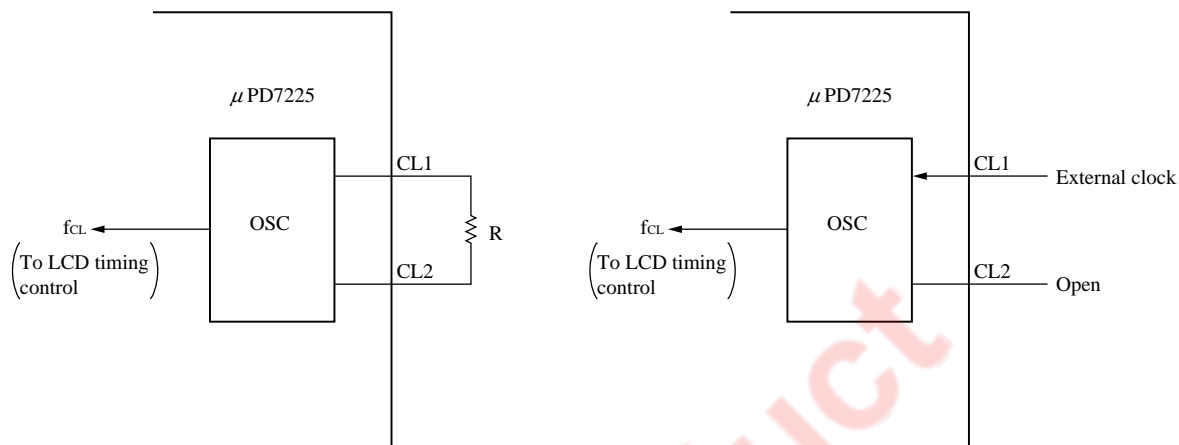

Remark f_{CL} = Clock oscillation frequency (when using the external clock, this frequency is same as that of the external clock frequency.)

When configuring a multi-chip system using the /SYNC pin, a clock with the same frequency and same phase must be supplied to the CL1 pin of each μ PD7225.

6. RESET FUNCTION

When a low level of 12 clock cycles or more is input to the /RESET pin, the μPD7225 will be reset to the following conditions:

- This condition is the same as when M2 – M0 = 0, F1, F0 = 0 are executed by the MODE SET command.
- Display data transfer from the data memory to the display data latch — This condition is the same as when the UNSYNCHRONIZED TRANSFER command is executed.
- Command/data register output — This condition is the same as when the WITHOUT SEGMENT DECODER command is executed.
- LCD display — This condition is the same as when the DISPLAY OFF or the BRINKING OFF command is executed.

Function when the μPD7225 is reset

- S0-S31 and COM0-COM3 pins output V_{DD}
- Serial data input — Disabled (/BUSY = 0) (However, /CS = 0)

When used in a multi-chip system, the reset state must be released (rising edge of /RESET) within 5 μs.

Figure 6-1. Reset Signal in Multi-Chip System

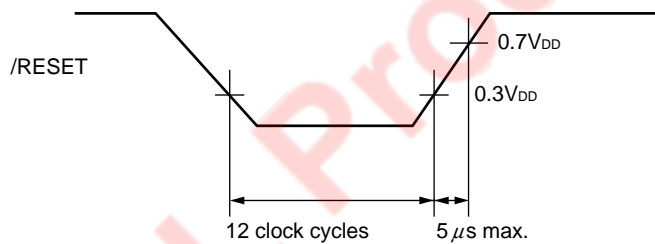

7. SERIAL DATA INPUT

Serial data is input to the SI pin with MSB first in synchronization with the serial clock in 8-bits units. When /CS is set to low, the μPD7225 sets the /BUSY to low (this initializes the SCK counter and the data pointer to 0) in order to perform internal processing. Therefore, after the μPD7225 completes internal processing, the first bit (MSB) should be input in synchronization with the /SCK after the /BUSY signal is set to high. The serial data is transferred to the serial register in bit units at the rising edge of /SCK. Inputting eight serial clocks completes the transfer of all 8 bits of data to the serial register. At the rising edge of the eighth serial clock, the /BUSY is set to low, and the status of the C, /D pin is clocked in to specify whether the data is a command or data. Afterwards, the contents of the serial register are clocked into the command/data register.

When successively inputting 2 or more bytes of serial data, /CS must be set to low until all bytes of data are input. The /BUSY is set to low each time a byte of data is input. The /BUSY becomes high when the serial data is clocked in from the serial register to the command/data register, so that the next serial data can be input.

When input of all serial data is complete, the data memory contents can be displayed by setting /CS to high. /CS must not be set to high while display data is being transferred (before eight clocks has elapsed.) If it becomes necessary to interrupt serial data transfer when transferring two or more bytes of data due to an interrupt for the CPU interrupt, execute the PAUSE TRANSFER command after checking that the byte has been transferred, then set /CS to high. In this case, even if /CS is set to high, the contents of the data memory will not be transferred to the display data latch.

To resume serial data transfer, set /CS to low in the same way as when initiating a normal transfer. However, in this case, the contents of the data pointer are not cleared so that data write operation starts from the next data memory address when serial data transfer is resumed (C, /D = 0).

Note In a multi-chip system in which the /BUSY pins of chips are made a wired-OR connection, avoid setting the /CS pins of two or more chips simultaneously.

Figure 7-1. Inputting Byte

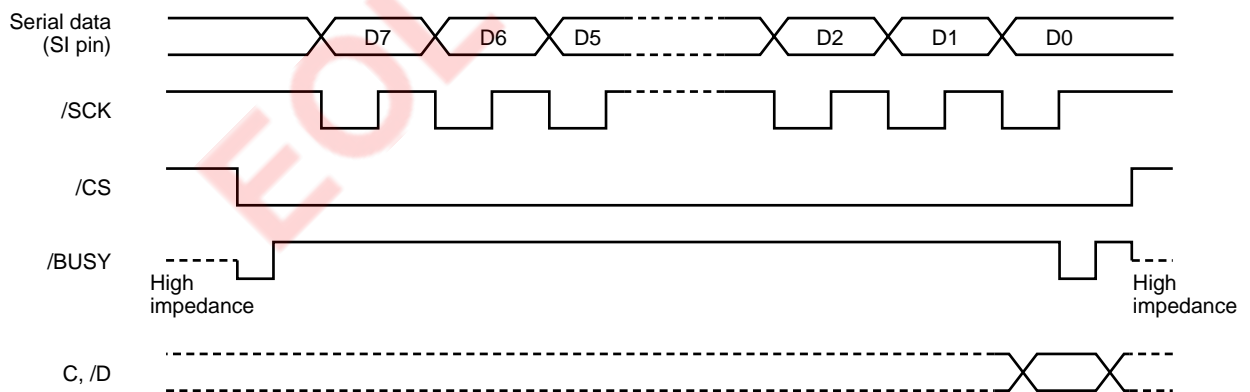
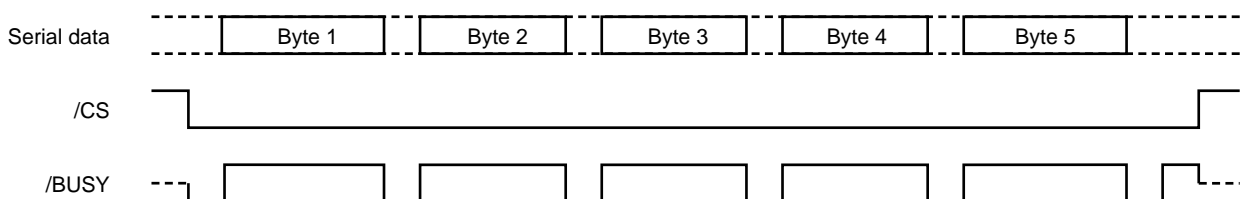
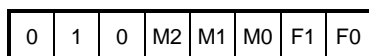

Figure 7-2. Inputting 5 Bytes Successively



8. COMMAND

8.1 MODE SET



This command sets the number of time divisions for the LCD display static drive or the time-division drive, bias method, and frame frequency.

(1) M1 and M0 specify the number of time divisions for static drive or time-division drive.

M1	M0	
0	0	----- Divide-by-4 time division drive
1	0	----- Divide-by-3 time division drive
1	1	----- Divide-by-2 time division drive
0	1	----- Static drive

(2) M2 specifies the bias method.

M2	
0	----- 1/3 bias method
1	----- 1/2 bias method
0/1	----- Static

(3) F1 and F0 specify the frequency division ratio which determines the frame frequency (refer to Figure 3-1).

F1	F0	Frequency division ratio
0	0	----- $1/2^7$
0	1	----- $1/2^8$
1	0	----- $1/2^9$
1	1	----- $1/2^{11}$

8.2 SYNCHRONIZED TRANSFER

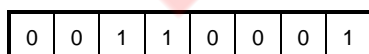

This command controls display data modification.

Normally, modification of display data is performed at the rising edge of the /CS signal (transferring display data from the data memory to the display data latch). However, after this command is executed, display data is modified at the first alternate current drive cycle (Frame frequency x Number of time divisions) after the /CS signal is set to high.

8.3 UNSYNCHRONIZED TRANSFER

0	0	1	1	0	0	0	0
---	---	---	---	---	---	---	---

This command controls display data modification.

After this command is executed, display data is modified at the rising edge of the /CS pin.

8.4 PAUSE TRANSFER

0	0	1	1	1	0	0	0
---	---	---	---	---	---	---	---

This command disables display data modification.

After this command is executed, display data can not be modified at the first rising edge of the /CS pin; instead, modification is put off until the second rising edge of the /CS pin. In addition, the data pointer is not cleared at the first rising edge of the /CS pin (refer to **2.5 Data Memory/Data Pointer**).

This command is used when it becomes necessary to set the /CS pin to high due to an interrupt for the CPU in the middle of serial data input operation.

8.5 BLINKING ON

0	0	0	1	1	0	1	K0
---	---	---	---	---	---	---	----

This command sets the blinking operation status. The blinking frequency is set by the least significant bit of the command (bit K0).

K0	Blinking frequency (Hz)
0	$f_{cl}/2^{17}$
1	$f_{cl}/2^{16}$

Remark f_{cl} : Clock oscillation frequency

8.6 BLINKING OFF

0	0	0	1	1	0	0	0
---	---	---	---	---	---	---	---

This command stops blinking operation.

8.7 DISPLAY ON

0	0	0	1	0	0	0	1
---	---	---	---	---	---	---	---

After this command is executed, LCD display operation starts according to the display data contained in the display data latch.

8.8 DISPLAY OFF

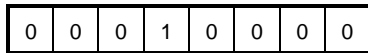

When this command is executed, the relationship of all common drive signals and segment drive signals enters the non-select state. As a result, the display is turned off. Transferring display data from the data memory to the display data latch is not affected by this command execution.

8.9 WITH SEGMENT DECODER

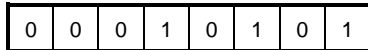

After this command is executed, input data is sent to the segment decoder, and the decoded code is written to the data memory.

8.10 WITHOUT SEGMENT DECODER

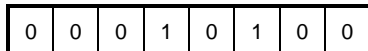

After this command is executed, input data is written to the data memory without going through the segment decoder.

8.11 LOAD DATA POINTER

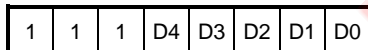

This command sets immediate data D4-D0 to the data pointer.

8.12 WRITE DATA MEMORY

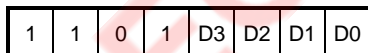

This command stores immediate data D3-D0 to the data memory addressed by the data pointer, and increments (+1) the contents of the data pointer.

8.13 OR DATA MEMORY

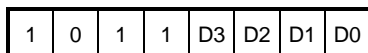

This command ORs the contents of the data memory addressed by the data pointer and immediate data D3-D0, and stores the result to the data memory, then increments (+1) the contents of the data pointer.

8.14 AND DATA MEMORY

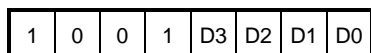

This command ANDs the contents of the data memory addressed by the data pointer and immediate data D3-D0, and stores the result to the data memory, then increments (+1) the contents of the data pointer.

8.15 CLEAR DATA MEMORY

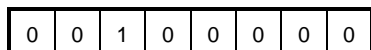

This command clears the contents of the data memory and the data pointer.

8.16 WRITE BLINKING DATA MEMORY

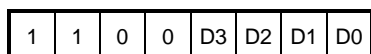

This command stores immediate data D3-D0 to the blinking data memory addressed by the data pointer, and increments (+1) the contents of the data pointer.

8.17 OR BLINKING DATA MEMORY

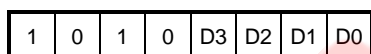

This command ORs the contents of the blinking data memory addressed by the data pointer and immediate data D3-D0, and stores the result to the blinking data memory, then increments (+1) the contents of the data pointer.

8.18 AND BLINKING DATA MEMORY

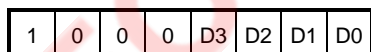

This command ANDs the contents of the blinking data memory addressed by the data pointer and immediate data D3-D0, and stores the result to the blinking data memory, then increments (+1) the contents of the data pointer.

8.19 CLEAR BLINKING DATA MEMORY

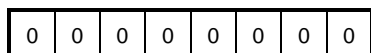

This command clears the contents of the blinking data memory and the data pointer.

9. DISPLAY OUTPUT

The following describes the serial data organization, display data organization in the data memory, segment drive signal, and common drive signal when the display is active in the static and divide-by-2, -3, -4 time division modes.

9.1 Static

When displaying just the digit “6” in the static mode:

- (1) Serial data organization: 0D, 07
- (2) Display data organization in the data memory

		Address							
		n + 7	n + 6	n + 5	n + 4	n + 3	n + 2	n + 1	n
Bit	Contents of bit 0	0	1	1	1	1	1	0	1

- (3) Power supply (static)
 - $V_{LC0} = V_{LC1} = V_{DD}$
 - $V_{LC2} = V_{LC3} = V_{DD} - V_{LCD}$
- (4) Relationship between common and segment

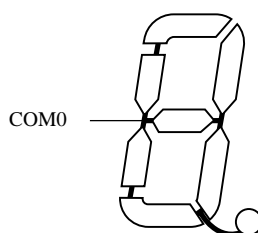
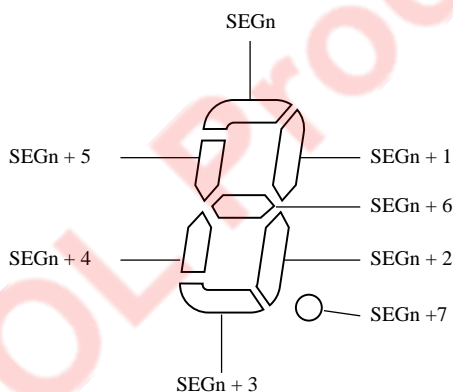

(5) Segment and common drive signals

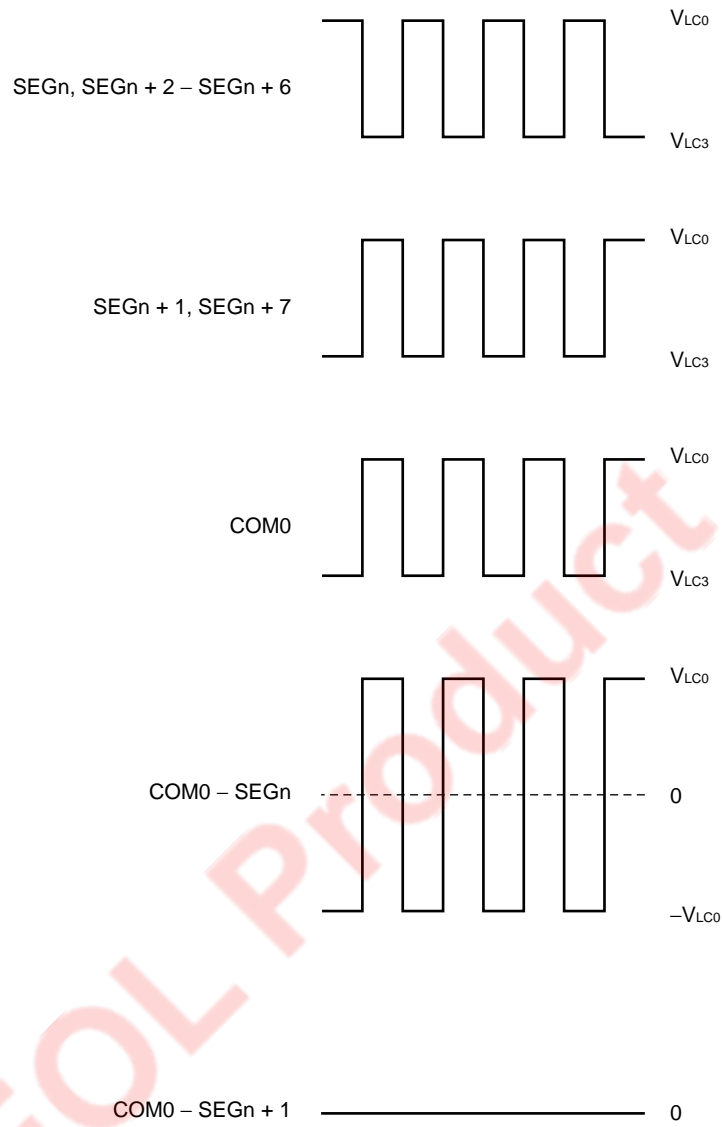

9.2 Divide-by-2 Time Division

When displaying just the digit “6” in the divide-by-2 time division mode:

- (1) Serial data organization: F5
- (2) Display data organization in the data memory

		Address			
		n + 3	n + 2	n + 1	n
Bit	Contents of bit 0	1	1	1	1
	Contents of bit 1	1	1	0	0

- (3) Power supply (1/2 bias)

$$V_{LC0} = V_{DD}$$

$$V_{LC1} = V_{LC2} = V_{DD} - 1/2 V_{LCD}$$

$$V_{LC3} = V_{DD} - V_{LCD}$$

- (4) Relationship between common and segment

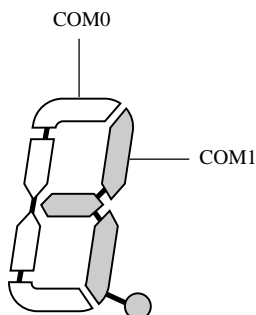
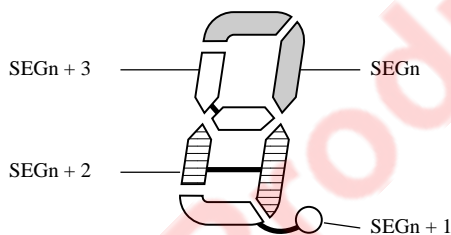

(5) Segment and common drive signals

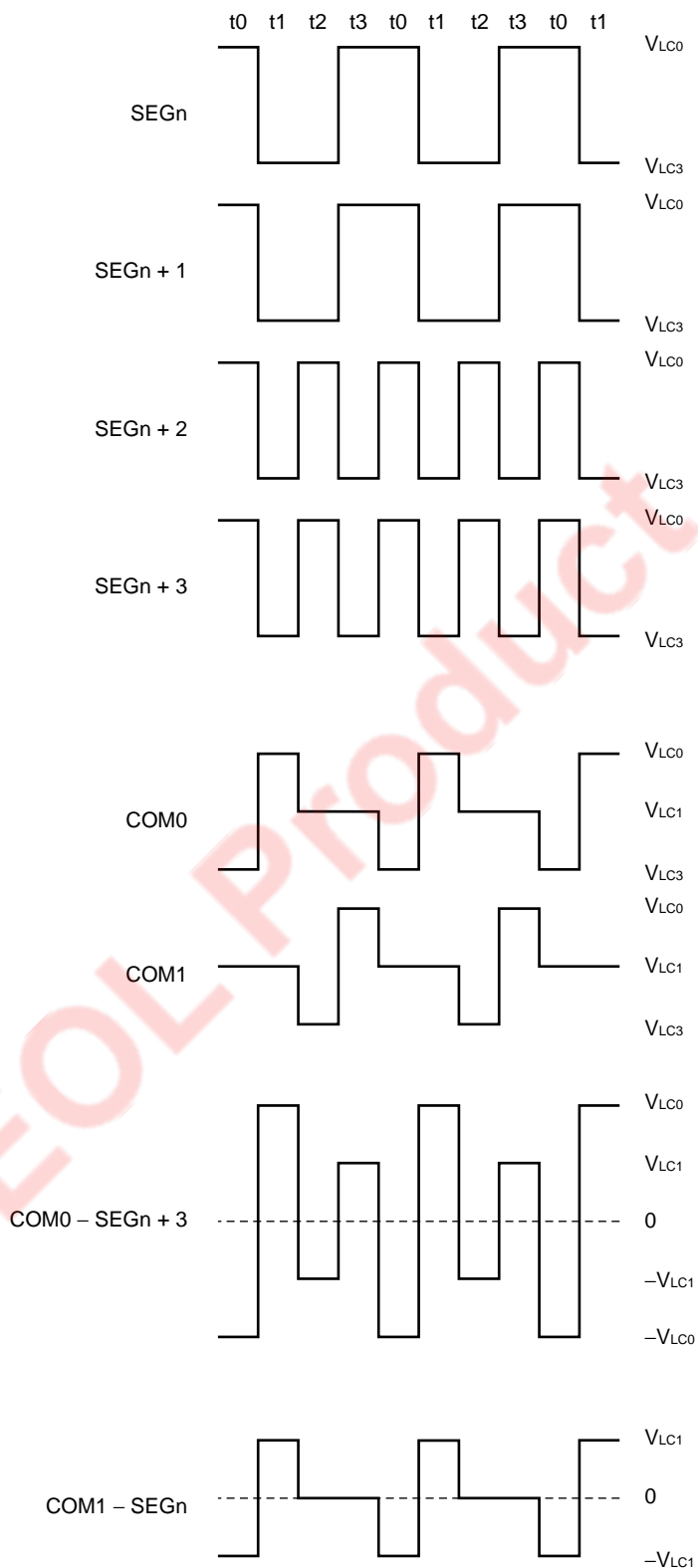

9.3 Divide-by-3 Time Division

When displaying the digit “6.” in the divide-by-3 time division mode:

- (1) Serial data organization
 - Without segment decoder : FE
 - With segment decoder : 06
(However, the floating point is set to “1” by command.)
- (2) Display data organization in the data memory

		Address		
		n + 2	n + 1	n
Bit	Contents of bit 0	1	1	0
	Contents of bit 1	1	1	1
	Contents of bit 2	0	1	1

- (3) Power supply (1/3 bias)

$$V_{LC0} = V_{DD}$$

$$V_{LC1} = V_{DD} - 1/3 V_{LCD}$$

$$V_{LC2} = V_{DD} - 2/3 V_{LCD}$$

$$V_{LC3} = V_{DD} - V_{LCD}$$

- (4) Relationship between common and segment

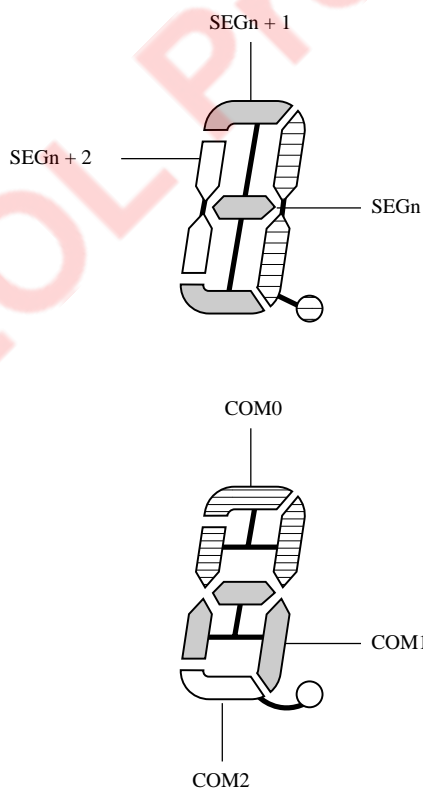

(5) Segment and common drive signals

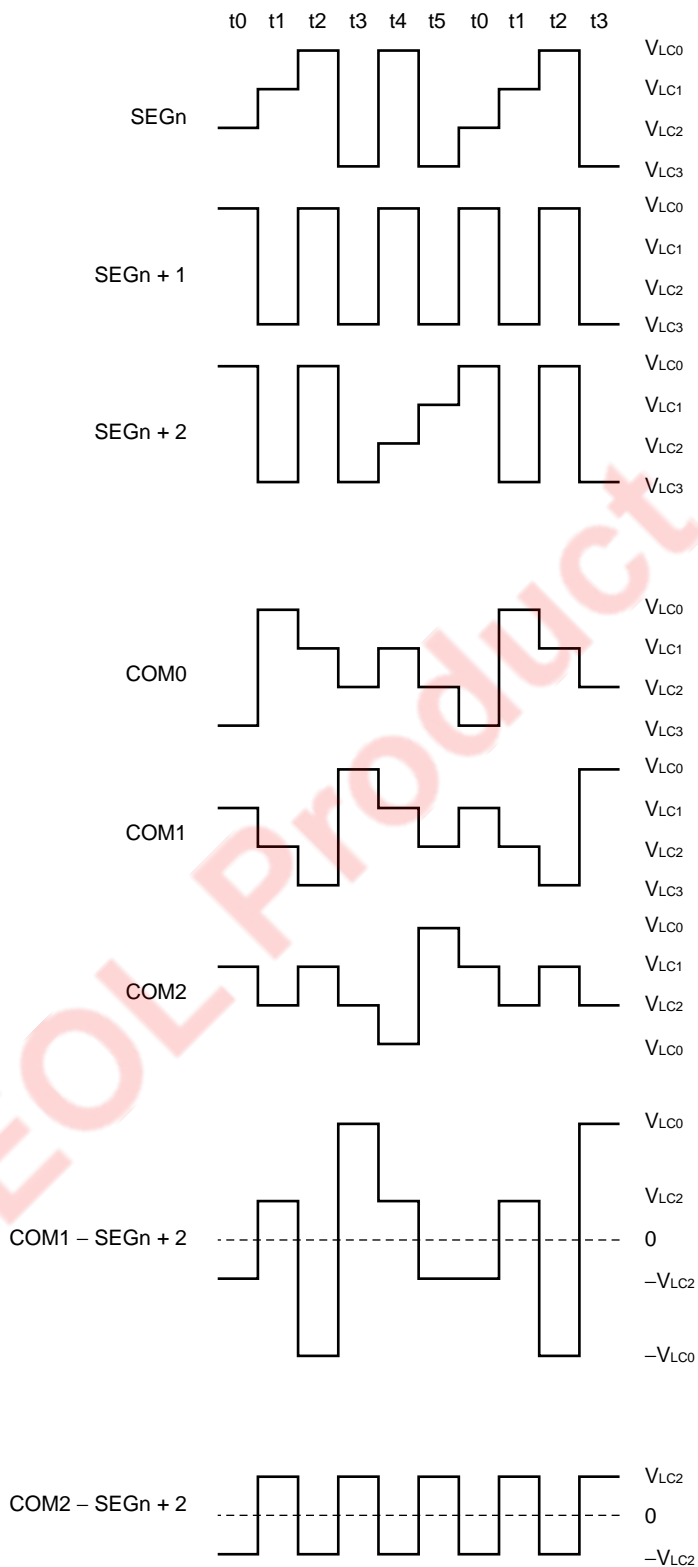

9.4 Divide-by-4 Time Division

When displaying the digit “6.” in the divide-by-4 time division mode:

(1) Serial data organization

- Without segment decoder : FD
- With segment decoder : 06
(However, the floating point is set to “1” by command.)

		Address	
		n + 1	n
Bit	Contents of bit 0	1	1
	Contents of bit 1	1	0
	Contents of bit 2	1	1
	Contents of bit 3	1	1

(2) Power supply (1/3 bias)

- $V_{LC0} = V_{DD}$
- $V_{LC1} = V_{DD} - 1/3 V_{LCD}$
- $V_{LC2} = V_{DD} - 2/3 V_{LCD}$
- $V_{LC3} = V_{DD} - V_{LCD}$

(3) Relationship between common and segment

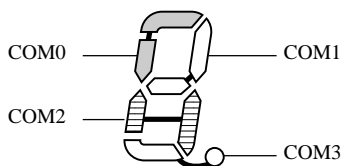
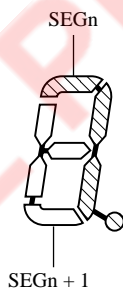

(4) Segment and common drive signals

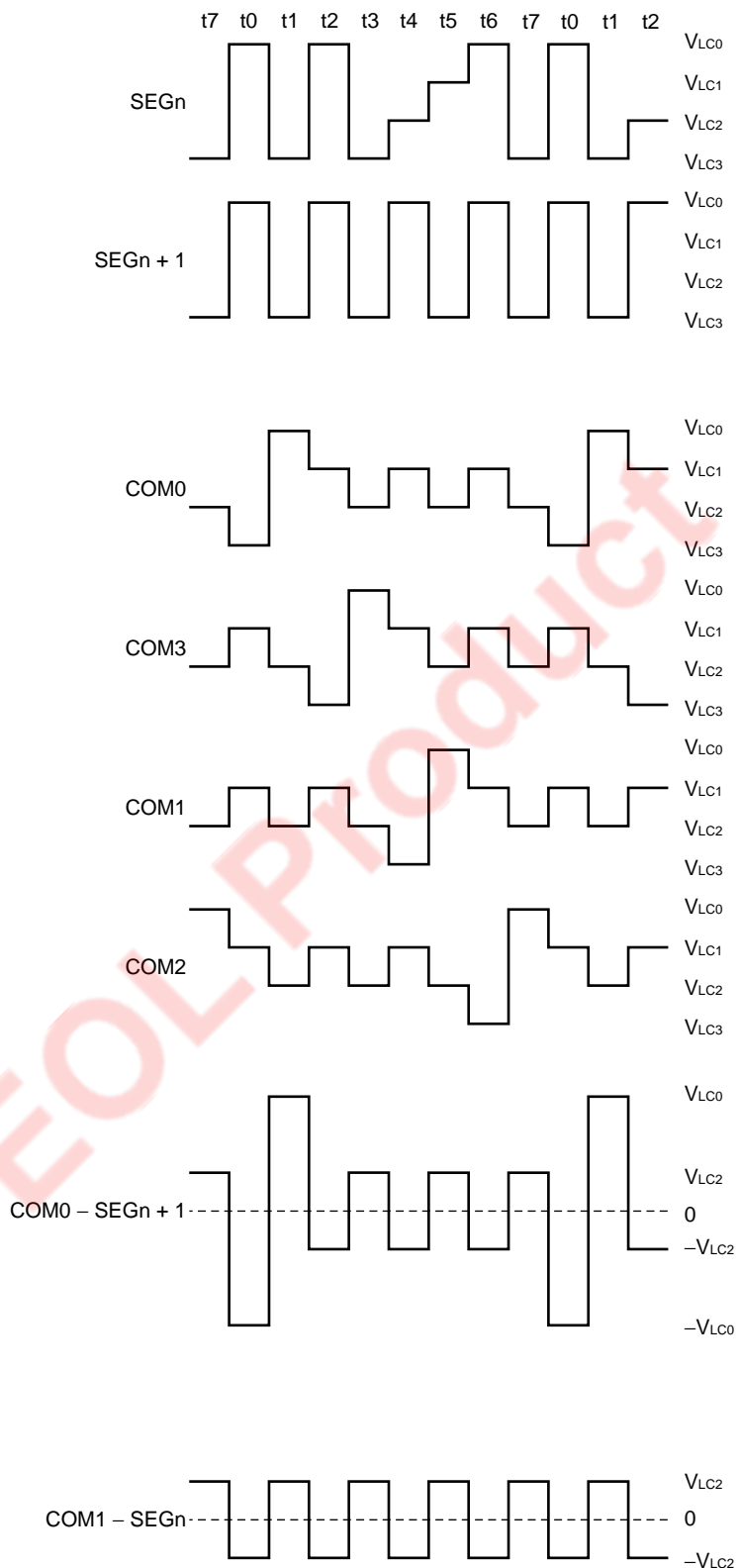

10. ELECTRICAL CHARACTERISTICS

Absolute Maximum Rating (T_A = 25 °C)

Item	Symbol	Condition	Rating	Units
Power supply voltage	V _{DD}		-0.3 to +7.0	V
Input voltage	V _I		-0.3 to V _{DD} +0.3	V
Output voltage	V _O		-0.3 to V _{DD} +0.3	V
Operating ambient temperature	T _A		-10 to +70	°C
Storage temperature	T _{stg}		-65 to +150	°C

Caution If the absolute maximum rating of even one of the above parameters is exceeded even momentarily, the quality of the product may be degraded. Absolute maximum ratings, therefore, specify the values exceeding which the product may be physically damaged. Be sure to use the product within the range of the absolute maximum ratings.

Capacitance (T_A = 25 °C, V_{DD} = 0 V)

Item	Symbol	Condition	MIN.	TYP.	MAX.	Units
Input capacitance	C _{IN}				10	pF
Output capacitance	C _{OUT1}	Except /BUSY			20	pF
Output capacitance	C _{OUT2}	/BUSY			15	pF
Input/output capacitance	C _{IO}	/SYNC			15	pF
Clock capacitance	C _C	CL1			30	pF

f = 1 MHz pins other than those used for measurement are 0 V.

DC Characteristics (T_A = -10 to +70 °C, V_{DD} = 5 V ± 10%)

Item	Symbol	Condition	MIN.	TYP.	MAX.	Unit
High level input voltage	V _{IH}		0.7 V _{DD}		V _{DD}	V
Low level input voltage	V _{IL}		0		0.3 V _{DD}	V
High level output voltage	V _{OH}	/SYNC, /BUSY, I _{OH} = -10 μA	V _{DD} - 0.5			V
Low level output voltage	V _{OL1}	/BUSY, I _{OL} = 100 μA			0.5	V
	V _{OL2}	/SYNC, I _{OL} = 900 μA			1.0	V
Output short-circuit current	I _{OS}	/SYNC, V _O = 1 V			-300	μA
High level input leakage current	I _{LIH}	V _I = V _{DD}			2	μA
Low level input leakage current	I _{LIL}	V _I = 0 V			-2	μA
High level output leakage current	I _{LOH}	V _O = V _{DD}			2	μA
Low level output leakage current	I _{LOL}	V _O = 0 V			-2	μA
Common output impedance	R _{COM}	COM0 to COM3 ^{Note 1} , V _{DD} ≥ V _{LCD}		5	7	kΩ
Segment output impedance	R _{SEG}	S0 to S31 ^{Note 1} , V _{DD} ≥ V _{LCD}		7	14	kΩ
Power supply voltage	I _{DD}	CL1 external clock, f _c = 200 kHz ^{Note 2}		100	250	μA

- Notes** 1. Applies to Static, 1/2 bias, 1/3 bias
 2. Abnormal current will flow if the external clock supply is removed.

DC Characteristics (T_A = 0 to +70 °C, V_{DD} = 2.7 to 5.5 V)

Item	Symbol	Condition	MIN.	TYP.	MAX.	Units
High level input voltage	V _{IH1}	Except /SCK	0.7 V _{DD}		V _{DD}	V
	V _{IH2}	/SCK	0.8 V _{DD}		V _{DD}	V
Low level input voltage	V _{IL1}	Except /SCK	0		0.3 V _{DD}	V
	V _{IL2}	/SCK	0		0.2 V _{DD}	V
High level output voltage	V _{OH}	/SYNC, /BUSY, I _{OH} = -7 μA	V _{DD} - 0.75			V
Low level output voltage	V _{OL1}	/BUSY, I _{OL} = 100 μA			0.5	V
	V _{OL2}	/SYNC, I _{OL} = 400 μA			0.5	V
Output short-circuit current	I _{OS}	/SYNC, V _O = 0.5 V			-200	μA
High level input leakage current	I _{LIH}	V _I = V _{DD}			2	μA
Low level input leakage current	I _{LIL}	V _I = 0 V			-2	μA
High level output leakage current	I _{LOH}	V _O = V _{DD}			2	μA
Low level output leakage current	I _{LOL}	V _O = 0 V			-2	μA
Common output impedance	R _{COM}	COM0 to COM3 ^{Note 1} , V _{DD} ≥ V _{LCD}		6		kΩ
Segment output impedance	R _{SEG}	S0 to S31 ^{Note 1} , V _{DD} ≥ V _{LCD}		12		kΩ
Power supply voltage	I _{DD}	CL external clock, V _{DD} = 3 V ± 10%, f _c = 140 kHz ^{Note 2}		30	100	μA

- Notes** 1. Applies to Static and 1/3 bias
 2. Abnormal current will flow if the external clock supply is removed.

AC Characteristics (T_A = -10 to +70 °C, V_{DD} = 5 V ± 10%)

Item	Symbol	Condition	MIN.	TYP.	MAX.	Units
Operating frequency	f _c		50		200	kHz
Oscillation frequency	f _{osc}	R = 180 kΩ ± 5%	85	130	175	kHz
High level clock pulse width	t _{WHC}	CL1, external clock	2		16	μs
Low level clock pulse width	t _{WLC}	CL1, external clock	2		16	μs
/SCK frequency	t _{cyk}		900			ns
High level /SCK pulse width	t _{WHK}		400			ns
Low level /SCK pulse width	t _{WLK}		400			ns
/BUSY ↑ → /SCK ↓ hold time	t _{HBK}		0			ns
SI set time (against /SCK ↑)	t _{SIK}		100			ns
SI hold time (against /SCK ↑)	t _{HKI}		200			ns
8th pulse of /SCK ↑ → /BUSY ↓ delay time	t _{DKB}	C _L = 50 pF			3	μs
/CS ↓ → /BUSY ↓ delay time	t _{DCSB}	C _L = 50 pF			1.5	μs
/BUSY low level time	t _{WLB}	t _{WHCS} ≥ 48/f _c ^{Note 1} C _L = 50 pF	4		44 (57) ^{Note 2}	1/f _c
C, /D set time (against 8th pulse of SCK ↑)	t _{SDK}		9			μs
C, /D hold time (against 8th pulse of SCK ↑)	t _{HKD}		1			μs
/CS hold time (against 8th pulse of SCK ↑)	t _{HKCS}		1			μs
High level /CS pulse width	t _{WHCS}		Note 3			μs
Low level /CS pulse width	t _{WLCS}		Note 3			μs
/SYNC load capacitance	C _{LSY}	t _{cyk} = 5 μs			50	pF

Notes 1. UNSYNCHRONIZED TRANSFER MODE

For SYNCHRONIZED TRANSFER MODE,
t_{WHCS} ≥ (48/f_c + AC driver frequency)

- 2. BLINKING ON
- 3. 8/f_c

AC Characteristics (T_A = 0 to +70 °C, V_{DD} = 2.7 V to 5.5 V)

Item	Symbol	Condition	MIN.	TYP.	MAX.	Unit
Operating frequency	f _c		50		140	kHz
Oscillation frequency	f _{osc}	R = 180 kΩ ± 5%, V _{DD} = 3 V ± 10 %	50	100	140	kHz
High level clock pulse width	t _{WHC}	CL1, external clock	3		16	μs
Low level clock pulse width	t _{WLC}	CL1, external clock	3		16	μs
/SCK frequency	t _{cyk}		4			μs
High level /SCK pulse width	t _{WHK}		1.8			μs
Low level /SCK pulse width	t _{WLK}		1.8			μs
/BUSY ↑→ /SCK hold time	t _{HBK}		0			ns
SI set time (against /SCK ↑)	t _{SIK}		1			μs
SI hold time (against /SCK ↑)	t _{HKI}		1			μs
8th pulse of /SCK ↑→ /BUSY ↓ delay time	t _{DKB}	C _L = 50 pF			5	μs
/CS ↓→ /BUSY ↓ delay time	t _{DCSB}	C _L = 50 pF			5	μs
/BUSY low level time	t _{WLB}	t _{WHCS} ≥ 48/f _c ^{Note 1} C _L = 50 pF	4		44 (57) ^{Note 2}	1/f _c
C, /D set time (against 8th pulse of SCK ↑)	t _{SDK}		18			μs
C, /D hold time (against 8th pulse of SCK ↑)	t _{HKD}		1			μs
/CS hold time (against 8th pulse of SCK ↑)	t _{HKCS}		1			μs
High level /CS pulse width	t _{WHCS}		Note 3			μs
Low level /CS pulse width	t _{WLCS}		Note 3			μs
/SYNC load capacitance	C _{LSY}	t _{cyk} = 7.1 μs			50	pF

- Notes**
1. UNSYNCHRONIZED TRANSFER MOD
For SYNCHRONIZED TRANSFER MODE,
t_{WHCS} ≥ (48/f_c + AC driver frequency)
 2. BLINKING ON
 3. 8/f_c

AC Timing Measurement Voltage

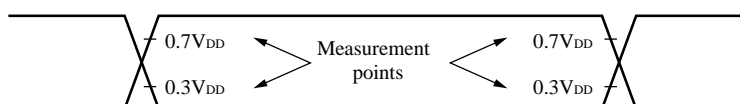

Timing Wave-Form

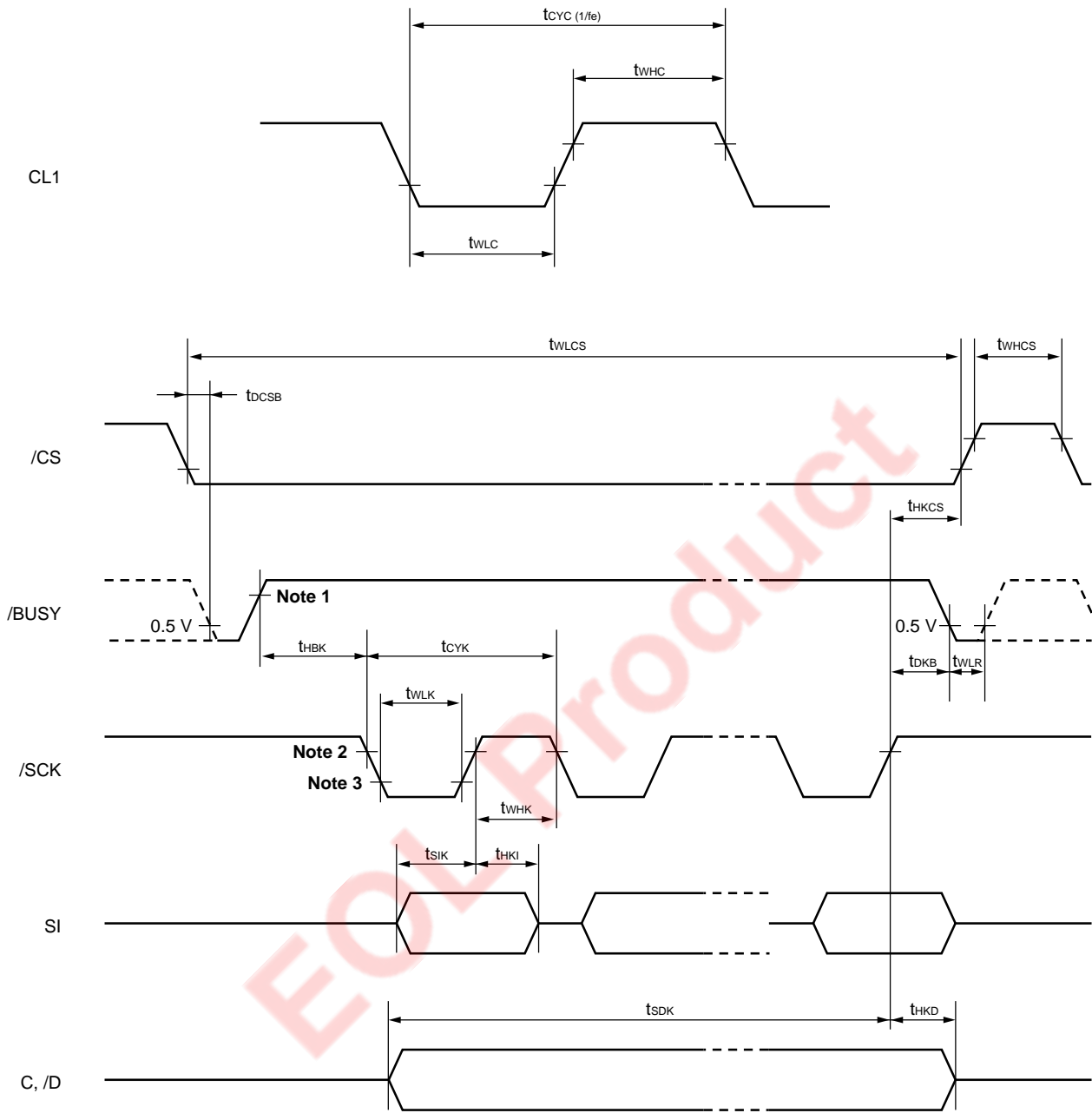

- Notes**
1. $V_{DD} - 0.5\text{ V}$ when $V_{DD} = 5\text{ V} \pm 10\%$, $V_{DD} - 0.75\text{ V}$ when $V_{DD} = 2.7\text{ to }5.5\text{ V}$
 2. 0.8 V when $V_{DD} = 2.7\text{ V to }5.5\text{ V}$
 3. 0.2 V when $V_{DD} = 2.7\text{ V to }5.5\text{ V}$

Typical Characteristic Curve (T_a = 25 °C)

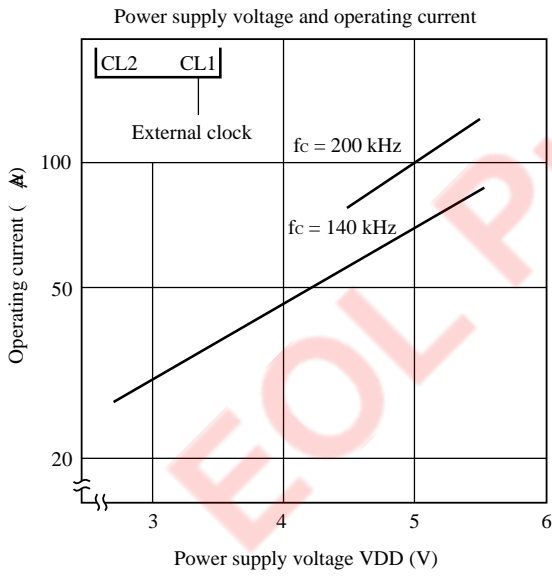
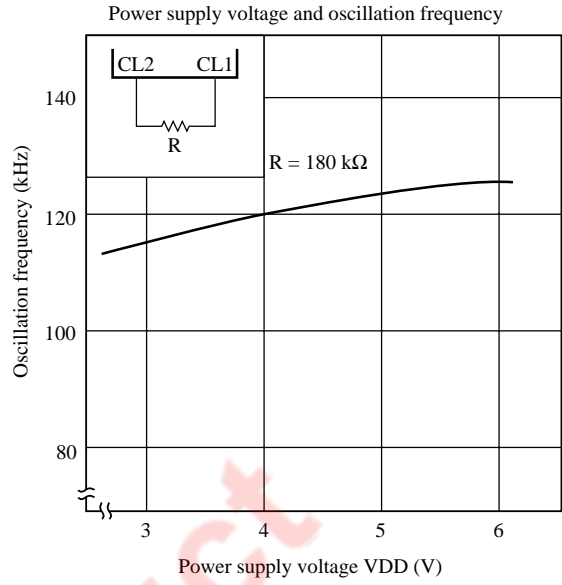
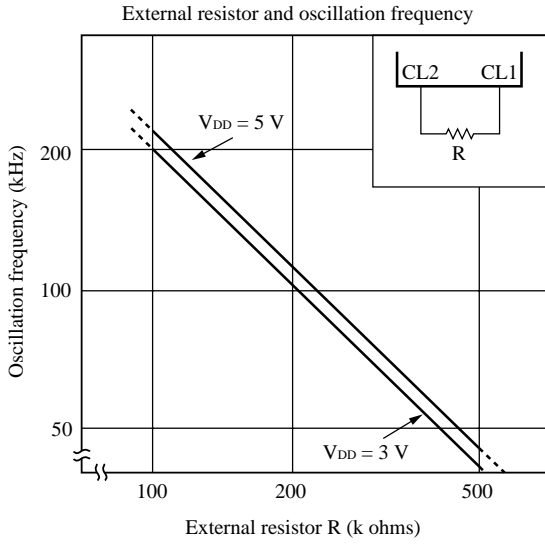

11. PACKAGE DRAWINGS

μPD7225G00

52 PIN PLASTIC QFP (14x14)

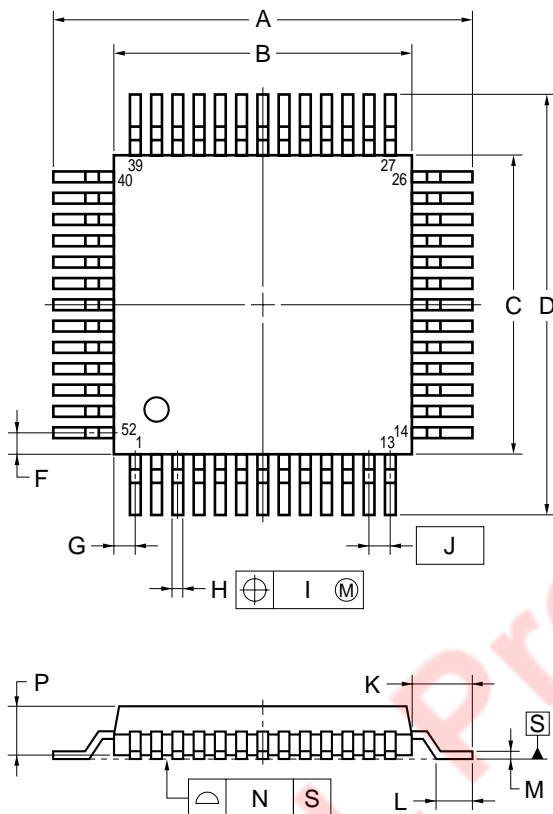

detail of lead end

NOTES

1. Controlling dimension — millimeter.
2. Each lead centerline is located within 0.20 mm of its true position (T.P.) at maximum material condition.

ITEM	MILLIMETERS	INCHES
A	21.0±0.4	0.827±0.016
B	14.0±0.2	0.551 ^{+0.009} _{-0.008}
C	14.0±0.2	0.551 ^{+0.009} _{-0.008}
D	21.0±0.4	0.827±0.016
F	1.0	0.039
G	1.0	0.039
H	0.42±0.08	0.017 ^{+0.003} _{-0.004}
I	0.20	0.008
J	1.0 (T.P.)	0.039
K	3.5±0.2	0.138 ^{+0.008} _{-0.009}
L	2.2±0.2	0.087 ^{+0.008} _{-0.009}
M	0.17 ^{+0.08} _{-0.07}	0.007 ^{+0.003} _{-0.004}
N	0.15	0.006
P	2.6 ^{+0.2} _{-0.1}	0.102 ^{+0.009} _{-0.004}
Q	0.1±0.1	0.004±0.004
S	3.0 MAX.	0.119 MAX.

P52G-100-00-3

μPD7225G01

52-PIN PLASTIC QFP (STRAIGHT) (14x14)

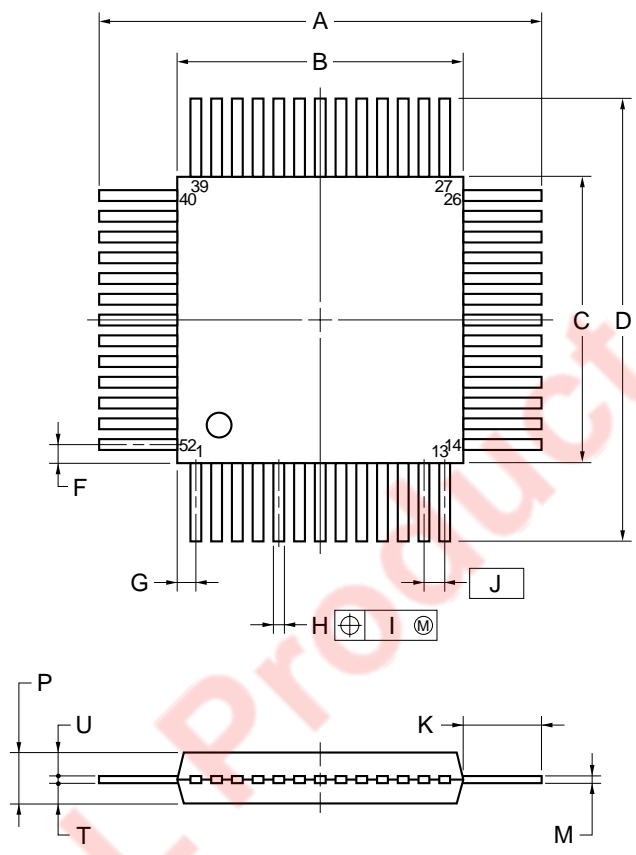

NOTE

Each lead centerline is located within 0.20 mm of its true position (T.P.) at maximum material condition.

ITEM	MILLIMETERS
A	22.0±0.4
B	14.0±0.2
C	14.0±0.2
D	22.0±0.4
F	1.0
G	1.0
H	0.40±0.10
I	0.20
J	1.0 (T.P.)
K	4.0±0.2
M	0.15 ^{+0.10} _{-0.05}
P	2.6 ^{+0.2} _{-0.1}
T	1.0
U	1.45

P52G-100-01-3

μPD7225GB-3B7

56-PIN PLASTIC QFP (10x10)

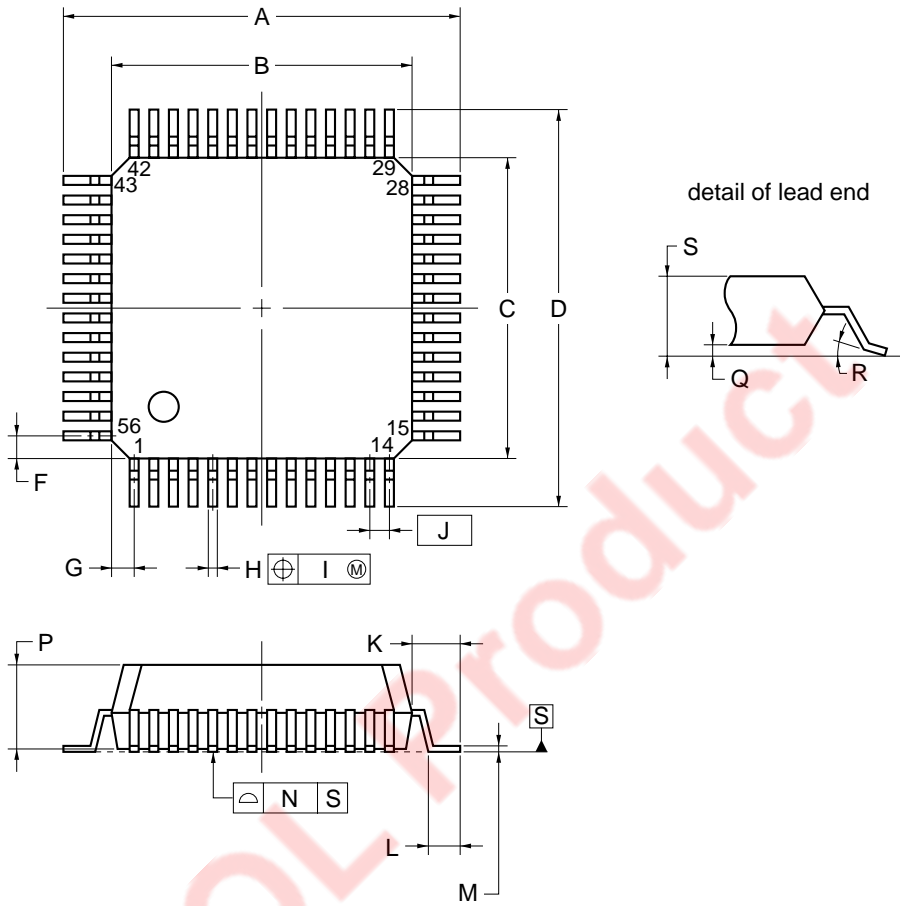

NOTE

Each lead centerline is located within 0.13 mm of its true position (T.P.) at maximum material condition.

ITEM	MILLIMETERS
A	13.2±0.4
B	10.0±0.2
C	10.0±0.2
D	13.2±0.4
F	0.75
G	0.75
H	0.30±0.10
I	0.13
J	0.65 (T.P.)
K	1.6±0.2
L	0.8±0.2
M	0.15 ^{+0.10} _{-0.05}
N	0.10
P	2.7
Q	0.1±0.1
R	5°±5°
S	3.0 MAX.

S56GB-65-3B7-4

μPD7225GC-AB6

★ 52 PIN PLASTIC QFP (14×14)

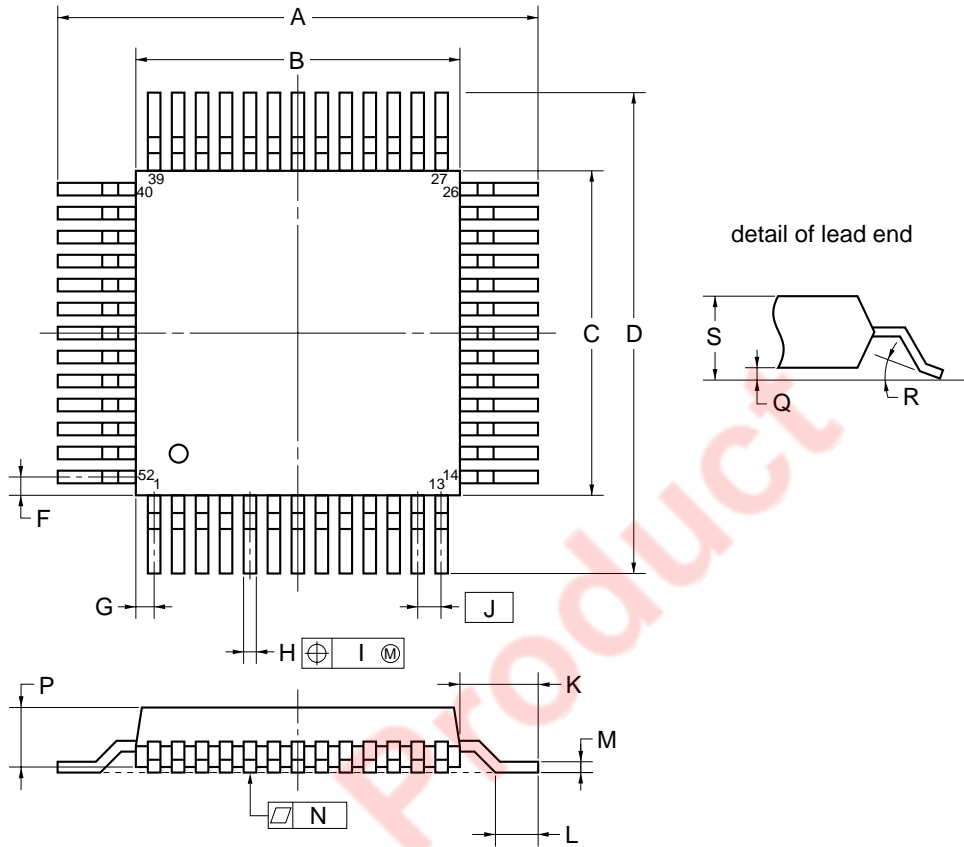

NOTE
 Each lead centerline is located within 0.20 mm (0.008 inch) of its true position (T.P.) at maximum material condition.

ITEM	MILLIMETERS	INCHES
A	17.6±0.4	0.693±0.016
B	14.0±0.2	0.551 ^{+0.009} _{-0.008}
C	14.0±0.2	0.551 ^{+0.009} _{-0.008}
D	17.6±0.4	0.693±0.016
F	1.0	0.039
G	1.0	0.039
H	0.40±0.10	0.016 ^{+0.004} _{-0.005}
I	0.20	0.008
J	1.0 (T.P.)	0.039 (T.P.)
K	1.8±0.2	0.071 ^{+0.008} _{-0.009}
L	0.8±0.2	0.031 ^{+0.009} _{-0.008}
M	0.15 ^{+0.10} _{-0.05}	0.006 ^{+0.004} _{-0.003}
N	0.10	0.004
P	2.6	0.102
Q	0.1±0.1	0.004±0.004
R	5°±5°	5°±5°
S	3.0 MAX.	0.119 MAX.

P52GC-100-AB6-4

12. RECOMMENDED SOLDERING CONDITIONS

When mounting the μPD7225 by soldering, soldering should be performed under the following recommended conditions.

Should other than recommended conditions be used, consult with our sales personnel.

Surface Mount Type

- μPD7225G00 : 52-pin plastic QFP (14 × 14 mm)
- μPD7225G01 : 52-pin plastic QFP (straight) (14 × 14 mm)
- ★ μPD7225GC-AB6 : 52-pin plastic QFP (14 × 14 mm)

Soldering Method	Soldering Condition	Symbol of Recommended Soldering Condition
Partial heating	Pin temperature: 300 °C MAX., Time: 3 seconds MAX. (per pin row)	–

- μPD7225GB-3B7 : 56-pin plastic QFP (10 × 10 mm)

Soldering Method	Soldering Condition	Symbol of Recommended Soldering Condition
Infrared reflow	Package peak temperature: 235 °C, Time: 30 seconds MAX. (210 °C or higher), Count: 3 times or less	IR35-00-3
VPS	Package peak temperature: 215 °C, Time: 40 seconds MAX. (200 °C or higher), Count: 3 times or less	VP-15-00-3
Wave soldering	Solder bath temperature: 260 °C MAX., Time: 10 seconds MAX., Counts: 1, Preheating temperature: 120 °C MAX. (package surface temperature)	WS-60-00-1
Partial heating	Pin temperature: 300 °C MAX., Time: 3 seconds MAX. (per pin row)	–

Caution Do not use two or more soldering methods in combination (except the partial heating method).

Reference Documents

- NEC Semiconductor Device Reliability / Quality Control System (C10983E)
- Quality Grades to NEC's Semiconductor Devices (C11531E)
- Semiconductor Device Mounting Technology Manual (C10535E)

NOTES FOR CMOS DEVICES**① PRECAUTION AGAINST ESD FOR SEMICONDUCTORS**

Note:

Strong electric field, when exposed to a MOS device, can cause destruction of the gate oxide and ultimately degrade the device operation. Steps must be taken to stop generation of static electricity as much as possible, and quickly dissipate it once, when it has occurred. Environmental control must be adequate. When it is dry, humidifier should be used. It is recommended to avoid using insulators that easily build static electricity. Semiconductor devices must be stored and transported in an anti-static container, static shielding bag or conductive material. All test and measurement tools including work bench and floor should be grounded. The operator should be grounded using wrist strap. Semiconductor devices must not be touched with bare hands. Similar precautions need to be taken for PW boards with semiconductor devices on it.

② HANDLING OF UNUSED INPUT PINS FOR CMOS

Note:

No connection for CMOS device inputs can be cause of malfunction. If no connection is provided to the input pins, it is possible that an internal input level may be generated due to noise, etc., hence causing malfunction. CMOS devices behave differently than Bipolar or NMOS devices. Input levels of CMOS devices must be fixed high or low by using a pull-up or pull-down circuitry. Each unused pin should be connected to V_{DD} or GND with a resistor, if it is considered to have a possibility of being an output pin. All handling related to the unused pins must be judged device by device and related specifications governing the devices.

③ STATUS BEFORE INITIALIZATION OF MOS DEVICES

Note:

Power-on does not necessarily define initial status of MOS device. Production process of MOS does not define the initial operation status of the device. Immediately after the power source is turned ON, the devices with reset function have not yet been initialized. Hence, power-on does not guarantee out-pin levels, I/O settings or contents of registers. Device is not initialized until the reset signal is received. Reset operation must be executed immediately after power-on for devices having reset function.

- **The information in this document is current as of May, 2002. The information is subject to change without notice. For actual design-in, refer to the latest publications of NEC's data sheets or data books, etc., for the most up-to-date specifications of NEC semiconductor products. Not all products and/or types are available in every country. Please check with an NEC sales representative for availability and additional information.**
 - No part of this document may be copied or reproduced in any form or by any means without prior written consent of NEC. NEC assumes no responsibility for any errors that may appear in this document.
 - NEC does not assume any liability for infringement of patents, copyrights or other intellectual property rights of third parties by or arising from the use of NEC semiconductor products listed in this document or any other liability arising from the use of such products. No license, express, implied or otherwise, is granted under any patents, copyrights or other intellectual property rights of NEC or others.
 - Descriptions of circuits, software and other related information in this document are provided for illustrative purposes in semiconductor product operation and application examples. The incorporation of these circuits, software and information in the design of customer's equipment shall be done under the full responsibility of customer. NEC assumes no responsibility for any losses incurred by customers or third parties arising from the use of these circuits, software and information.
 - While NEC endeavours to enhance the quality, reliability and safety of NEC semiconductor products, customers agree and acknowledge that the possibility of defects thereof cannot be eliminated entirely. To minimize risks of damage to property or injury (including death) to persons arising from defects in NEC semiconductor products, customers must incorporate sufficient safety measures in their design, such as redundancy, fire-containment, and anti-failure features.
 - NEC semiconductor products are classified into the following three quality grades:
 "Standard", "Special" and "Specific". The "Specific" quality grade applies only to semiconductor products developed based on a customer-designated "quality assurance program" for a specific application. The recommended applications of a semiconductor product depend on its quality grade, as indicated below. Customers must check the quality grade of each semiconductor product before using it in a particular application.
 "Standard": Computers, office equipment, communications equipment, test and measurement equipment, audio and visual equipment, home electronic appliances, machine tools, personal electronic equipment and industrial robots
 "Special": Transportation equipment (automobiles, trains, ships, etc.), traffic control systems, anti-disaster systems, anti-crime systems, safety equipment and medical equipment (not specifically designed for life support)
 "Specific": Aircraft, aerospace equipment, submersible repeaters, nuclear reactor control systems, life support systems and medical equipment for life support, etc.
- The quality grade of NEC semiconductor products is "Standard" unless otherwise expressly specified in NEC's data sheets or data books, etc. If customers wish to use NEC semiconductor products in applications not intended by NEC, they must contact an NEC sales representative in advance to determine NEC's willingness to support a given application.
- (Note)
- (1) "NEC" as used in this statement means NEC Corporation and also includes its majority-owned subsidiaries.
 - (2) "NEC semiconductor products" means any semiconductor product developed or manufactured by or for NEC (as defined above).